



# PHOENIX DISPLAY INTERNATIONAL, INC.

---

## PHOENIX DISPLAY INTERNATIONAL, INC SPECIFICATION FOR LCD MODULE

|                    |                      |
|--------------------|----------------------|
| <b>CUSTOMER</b>    |                      |
| <b>PART NUMBER</b> | PDI1280120110-2      |
| <b>DESCRIPTION</b> | 11.0" TFT 1280 x 120 |
| <b>VERSION</b>     | 1.0                  |
| <b>ISSUE DATE</b>  | 03-16-2010           |

**COMPANY ADDRESS :**

Phoenix Display International, Inc.  
6150 W. Gila Springs Place, Unit 2  
Chandler, AZ 85226  
USA

[www.phoenixdisplay.com](http://www.phoenixdisplay.com)

(630) 359-5700 office

(630) 359-5701 fax



## **Table of Contents**

- **GENERAL INFORMATION**
- **MECHANICAL DIMENSIONS**
- **ABSOLUTE MAXIMUM RATINGS**
- **ELECTRICAL CHARACTERISTICS**
- **BACKLIGHT CHARACTERISTICS**
- **ELECTRO-OPTICAL CHARACTERISTICS**
- **INTERFACE DESCRIPTION**
- **INTERFACE TIMING**
- **INSTRUCTION LIST TABLE**
- **RELIABILITY TESTING**
- **INSPECTION CRITERIA**
- **INSPECTION STANDARD**
- **PRECAUTIONS FOR USING LCD MODULES**

- **GENERAL INFORMATION**

| <b>Item</b>                   | <b>Contents</b>                  | <b>Unit</b>     |
|-------------------------------|----------------------------------|-----------------|
| LCD Type                      | TFT Transmissive, normally white | ---             |
| Technology                    | a-Si TFT                         | ---             |
| Viewing Angle                 | 12 O'Clock                       | O'clock         |
| Module dimensions (W x H x T) | 288.92 x 38.60 x 7.60            | mm              |
| Active area (W x H)           | 280.32 x 27.0                    | mm              |
| Number of pixels              | 1280 x 3(RGB) x 120              | ---             |
| Pixel pitch (W x H)           | 0.219 x 0.225                    | mm <sup>2</sup> |
| Colours                       | 262k                             | ---             |
| Backlight                     | LED                              | ---             |
| Interface                     | 6-bit RGB                        | ---             |
| Touch panel                   | None                             | ---             |
| Controller IC                 | Himax HX8232-B + HX8655-C        | ---             |
| Operating temperature         | -10 to +60                       | °C              |
| Storage temperature           | -20 to +70                       | °C              |

# MECHANICAL DIMENSIONS

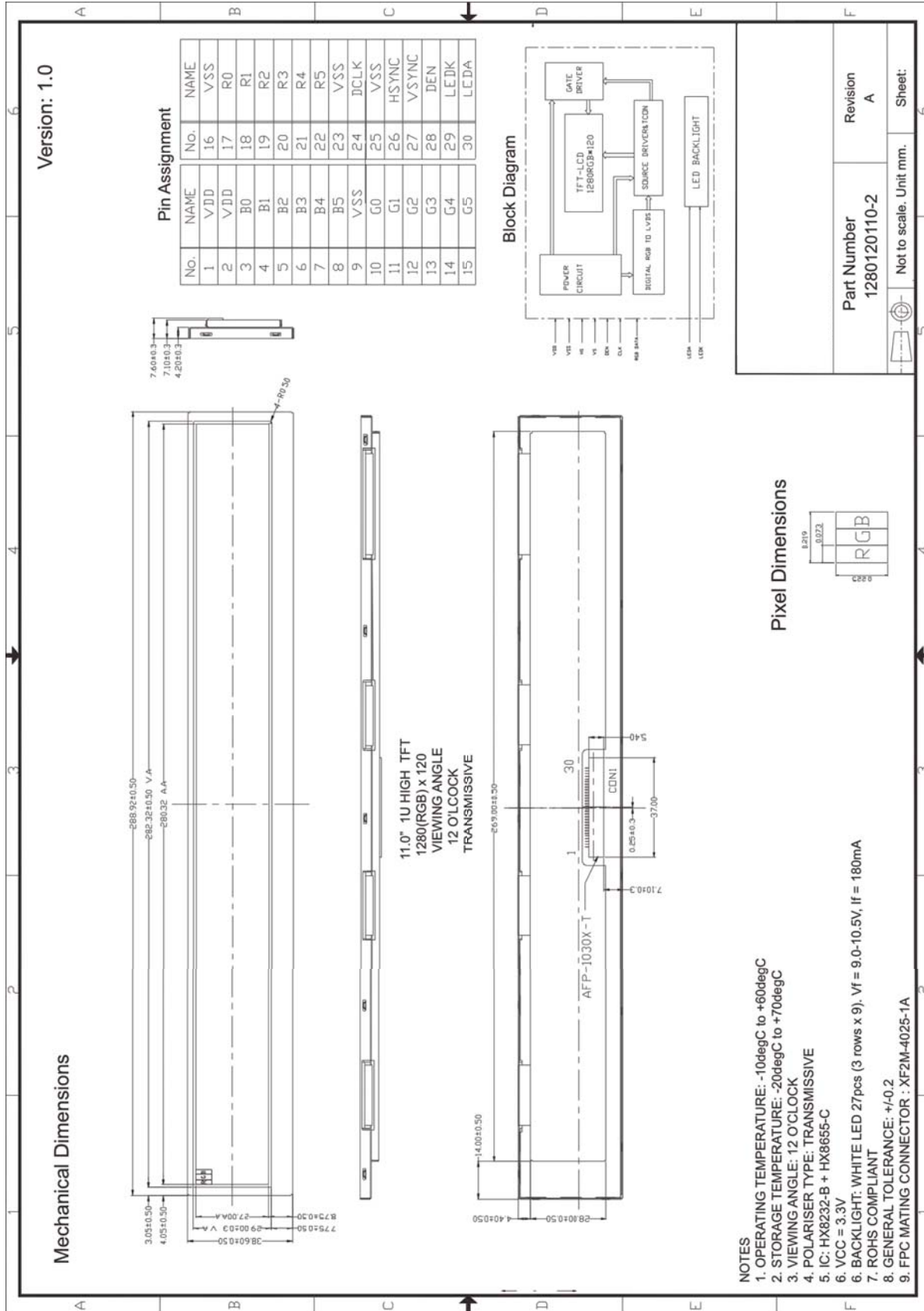

• **ABSOLUTE MAXIMUM RATINGS**

| Parameter             | Symbol    | Min.  | Max.           | Unit | Note    |
|-----------------------|-----------|-------|----------------|------|---------|
| Power Supply Voltages | $V_{DD}$  | - 0.3 | 3.6            | V    | GND = 0 |
| Input voltage         | $V_{IN}$  | - 0.3 | $V_{DD} + 0.3$ | V    | ---     |
| Operating Temperature | $T_{OPR}$ | - 10  | 60             | °C   | Note 1  |
| Storage temperature   | $T_{ST}$  | - 20  | 70             | °C   | Note 1  |

Note 1: Response time will be slower (delayed) at lower temperatures approaching the maximum operating temperature. At temperatures approaching the maximum operating temperature the LCD will experience a darker color. However this phenomena is an inherent property of LCDs and in no way means the LCD has malfunctioned.

• **ELECTRICAL CHARACTERISTICS**

| Parameter                | Symbol       | Min          | Typ. | Max          | Unit | Remark |
|--------------------------|--------------|--------------|------|--------------|------|--------|
| Supply Voltage for Logic | $V_{DD-VSS}$ | 3.2          | 3.3  | 3.4          | V    |        |
| Input Current            | $I_{dd}$     | ---          | 260  | 520          | mA   |        |
| Input Voltage Level 'H'  | $V_{IH}$     | $0.8 V_{DD}$ | ---  | $V_{DD}$     | V    |        |
| Input Voltage Level 'L'  | $V_{IL}$     | 0            | ---  | $0.2 V_{DD}$ | V    |        |
| Output Voltage Level 'H' | $V_{OH}$     | $0.8V_{DD}$  | ---- | $V_{DD}$     | V    |        |
| Output Voltage Level 'L' | $V_{OL}$     | 0            | ---  | $0.2V_{DD}$  | V    |        |

• **BACKLIGHT CHARACTERISTICS**

| Item                    | Symbol          | Min.                 | Typ. | Max. | Unit              | Condition   |
|-------------------------|-----------------|----------------------|------|------|-------------------|-------------|
| Forward Current Voltage | $V_F$           | 9                    | 9.6  | 10.5 | V                 | $I_f=180mA$ |
| Luminance               | $L_v$           | ---                  | 6000 | ---  | cd/m <sup>2</sup> | Per LED     |
| Connection methof       | Series/Parallel | 3 series, 9 parallel |      |      | ---               | ---         |

Notes

• **Backlight drive conditions : external constant current driving method.**

- The LED driving condition is defined for the total backlight consumption.
- Forward Voltage adjusting should depend on Forward Current setting.
- Optical performance should be evaluated at  $T_a=25^{\circ}C$  only.
- If the LEDs are driven by high current, high ambient temperature & humidity condition the lifetime of the LEDs will be reduced.

- Operating life means brightness reduces to 50% of initial brightness.
- Typical operating lifetime is estimated data.

• **ELECTRO-OPTICAL CHARACTERISTICS**

| Item                   | Symbol           | Condition | Min.         | Typ. | Max.  | Unit              | Refer | Note   |   |
|------------------------|------------------|-----------|--------------|------|-------|-------------------|-------|--------|---|
| Response Time          | T <sub>ON</sub>  | 25°C      | ---          | 15   | 23    | ms                | Fig 1 | 1      |   |
|                        | T <sub>OFF</sub> |           | ---          | 23   | 34    |                   |       |        |   |
| Contrast ratio         | Cr               | θ = 0°    | 300          | 700  | ---   | ---               | Fig 2 | 1      |   |
| Uniformity             | U                | ---       | 75           | 84   | ---   | %                 | Fig 2 | 3      |   |
| Surface Luminance      | Lv               |           | 360          | 450  | ---   | cd/m <sup>2</sup> | Fig 2 | 2      |   |
| Viewing angle ratio    | θ                | ∅ = T     | 70           | 80   | ---   | deg               | Fig 3 | 6      |   |
|                        |                  | ∅ = B     | 70           | 80   | ---   |                   |       |        |   |
|                        |                  | ∅ = L     | 70           | 80   | ---   |                   |       |        |   |
|                        |                  | ∅ = R     | 70           | 80   | ---   |                   |       |        |   |
| CIE (x,y) chromaticity | Red              | x         | Backlight On | ---  | 0.575 | ---               | ---   | Fig 2. | 5 |
|                        |                  | y         |              | ---  | 0.329 | ---               |       |        |   |
|                        | Green            | x         |              | ---  | 0.354 | ---               |       |        |   |
|                        |                  | y         |              | ---  | 0.563 | ---               |       |        |   |
|                        | Blue             | x         |              | ---  | 0.147 | ---               |       |        |   |
|                        |                  | y         |              | ---  | 0.072 | ---               |       |        |   |
|                        | White            | x         |              | ---  | 0.307 | ---               |       |        |   |
|                        |                  | y         |              | ---  | 0.320 | ---               |       |        |   |

Note

1. Contrast ratio (CR) is defined mathematically in Figure 2.

$$\text{Contrast Ratio} = \frac{\text{Average Surface Luminance with all white pixels (P1, P2, P3, P4, P5)}}{\text{Average Surface Luminance with all black pixels (P1, P2, P3, P4, P5)}}$$

Note 2. Surface luminance is the LCD surface from the surface with all pixels displaying white. For more information see figure 2.

$$L_v = \text{Average Surface Luminance with all white pixels (P1, P2, P3, P4, P5...)}$$

Note 3. Uniformity of surface luminance,  $\delta$  White, is defined mathematically in figure 2.

$$\delta \text{ White} = \frac{\text{Minimum Surface Luminance with all white pixels (P1, P2, P3, P4, P5)}}{\text{Maximum Surface Luminance with all white pixels (P1, P2, P3, P4, P5)}}$$

Note 4. Response time is the time required for the display to transition from white to black (rise time  $T_r$ ) and from black to white (decay or fall time,  $T_f$ ). The industry standard test equipment used is the Autronic-Melcher's Conoscope.

Note 5. CIE (x,y) chromaticity. The x,y value is determined by measuring luminance at each test position 1 through 5, then calculating the average value.

Note 6. The Viewing angle is the angle at which the contrast ratio is greater than 2. For a TFT module, the contrast ratio is greater than 10. The angles are determined for the horizontal or 'x' axis and the vertical or 'y' axis with respect to the 'z' axis, being the LCD surface reference. Also see figure 3.

Note 7. For viewing angle and response time testing, the testing data is based on Autronic-Melcher's BM-7A. For the contrast ratio, surface luminance, luminance uniformity and chromaticity (CIE), the test data is based on the industry's standard SR-3A photo detector.

Note 8. For TFT modules, grey scale reversing occurs in the direction of the panel viewing angle.

Figure 1. Definition of response time

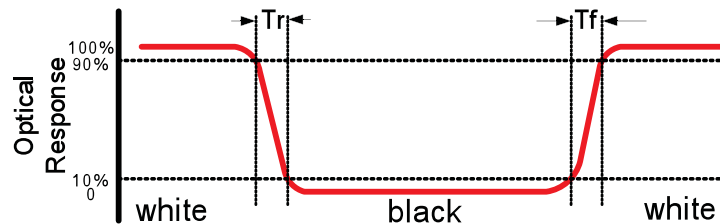

Figure 2. Measuring contrast ratio, surface luminance, luminance uniformity and CIE (chromaticity.)

A : 5mm, B : 5mm, H, V : Active area, Light spot size  $\theta = 7\text{mm}$ , 500mm distance from the LCD surface to the detector lens. Measurement instrument is Topcon's luminance meter BM-5.

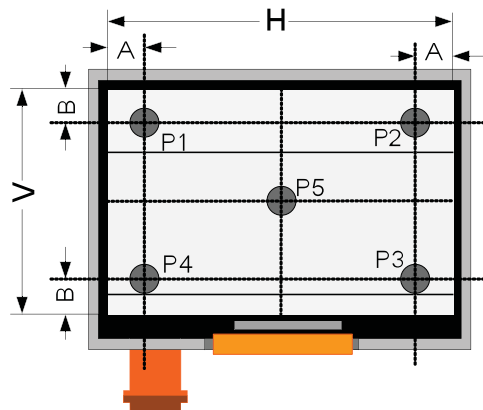
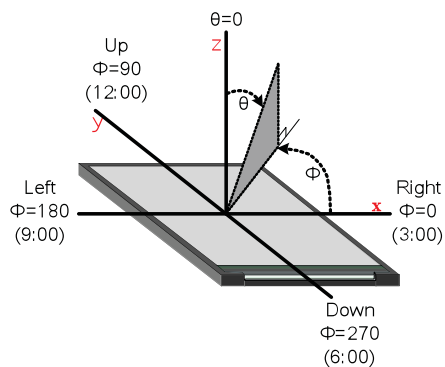



Figure 3. Definition of viewing angle



• **INTERFACE DESCRIPTION**

| Pin   | Symbol | Function                | Level |
|-------|--------|-------------------------|-------|
| 1     | VDD    | Digital Power Supply    | 3.3V  |
| 2     | VDD    | Digital Power Supply    | 3.3V  |
| 3-8   | B0-B5  | Blue Data               | H/L   |
| 9     | VSS    | Ground                  | 0V    |
| 10-15 | G0-G5  | Green Data              | H/L   |
| 16    | VSS    | Ground                  | 0V    |
| 17-22 | R0-R5  | Red Data                | H/L   |
| 23    | VSS    | Ground                  | 0V    |
| 24    | DCLK   | Data Clock              | H/L   |
| 25    | VSS    | Ground                  | 0V    |
| 26    | HSYNC  | Horizontal Synch Signal | H/L   |
| 27    | VSYN   | Vertical Synch Signal   | H/L   |
| 28    | DEN    | Data Enable Signal      | H/L   |
| 29    | LEDK   | Backlight LED cathode   | ---   |
| 30    | LEDA   | Backlight LED anode     | ---   |

• **RELIABILITY TESTING**

| <b>NO.</b> | <b>Item</b>                              | <b>Condition</b>  | <b>Criteria</b>  |
|------------|--|---|--|
| 1          | High Temperature Operating               | 70°C +/-2°C, 240Hrs   | IEC60068-2-1, GB2423.2   |
| 2          | Low Temperature Operating                | -20°C +/-2°C, 240Hrs  | IEC60068-2-1<br>GB2423.1   |
| 3          | High Temperature Storage                 | 80°C +/-2°C, 240Hrs   | IEC60068-2-1<br>GB2423.2   |
| 4          | Low Temperature Storage                  | -30°C +/-2°C, 240Hrs  | IEC60068-2-1<br>GB2423.2   |
| 5          | Hi Temperature & High Humidity Operation | 60°C, 90%RH max, 240Hrs   | IEC60068-2-78<br>GB/T2423.3  |
| 6          | Vibration (non operating)                | Frequency range:10~55Hz,<br>Stroke:1.5mm Sweep:10Hz~55Hz<br>~10Hz2hours for each direction of<br>x.y.z (6 hours for total)                | IEC60068-2-6<br>GB/T2423.10  |
| 7          | Package Vibration Test                   | Random Vibration:<br>0.015GxG/Hz for 5-200Hz,<br>-6dB/Octave from 200-500Hz<br>2 hours for each direction of X,Y,Z<br>(6 hours for total) | IEC60068-2-34<br>GB/T2423.11   |
|            | Thermal Shock (non operating)            | -20°C to 30min to 70°C, 30min<br>Change time: 5min, 100 cycles  | Start with cold temperature,<br>End with high temperature,<br>IEC60068-2-<br>14:1984,GB2423.22 |
| 9          | Drop Test (packaged)                     | Height:80 cm,1 corner, 3 edges, 6 surfaces  | IEC60068-2-32<br>GB/T2423.8  |
| 10         | Shock (non-operation)                    | 80G 6ms, ±X,±Y,±Z 3 times for each direction  | IEC60068-2-27<br>GB/T2423.5  |
| 11         | ESD (operation)                          | C=150pF,R=330Ω,<br>Air:±15Kv, Contact:±8Kv,<br>10times/terminal   | IEC61000-4-2<br>GB/T17626.2  |

Notes:

1. Test samples are applied to one test item.
2. Sample size for each test item is 2-10pcs.
3. For humidity testing, a pure water resistance of >10MW should be used.
4. (a) In the case of a malfunction caused by ESD damage, if the LCM returns to it's normal state after resetting, the item is considered to have passed the ESD test.  
(b) It is recommended to use an anti-static blower (ioniser) to reduce the electro-static voltage in the working area.  
(c) When removing the protection film from the LCM panel, peel off the film slowly (more than 1sec) while blowing the ioniser towards the peeling area to minimize ESD. This will reduce the risk of damaging the electrical circuitry.
5. EL backlights are exempt from the reliability testing with respect to temperature and humidity. Some defects many occur such as black spots or blemishes due to the inherent chemical reaction of humidity with fluorescent EL.
6. If it is installed, please use the automatic test mode on the LCM &/or demonstration box when testing.

• **INSPECTION CRITERIA**

This specification is designed to be used as the standard acceptance/rejection criteria for normal LCM products.

1. Sampling plan.

The sampling plan according to GB/T 2828.1-2003 / ISO2859-16 1999 and ANSI/ASQC Z1.4 1993, normal level 2 and based on:

- Major defect: AQL 0.65
- Minor defect: AQL 1.5

2. Inspection condition

- The viewing distance for cosmetic inspection is approximately 30cm with the naked eye, and under an environment of 20-40W light intensity, in all directions, within 45° against a perpendicular line. (Normal temperature 20-25°C and normal humidity 60+/-15 RH.)
- Driving voltage - The Vop value from which the most optimal contrast can be obtained near the specified Vop in the specification (within +/-0.5V of the typical value at 25°C.)

3. Definition of inspection zone in LCD.

Zone A : active pixel area

Zone B : viewing area except Zone A (Zone A + Zone B = Minimum viewing area)

Zone C : Outside viewing area (invisible area after assembling customer's product.

Figure 4 inspection zones in an LCD

Figure 4

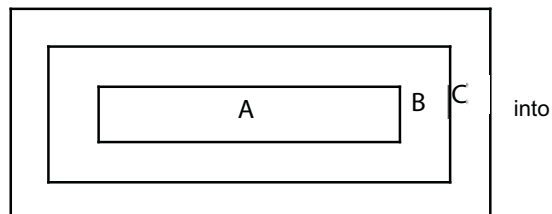

Note: As a general rule visual defects in Zone C are permissible when there is no visual effect once assembled into the customer's product.

• **INSPECTION STANDARD**

○ **MAJOR CRITERIA**

| Item No | Item to be inspected   | Inspection standard  | Classification |
|---------|------------------------|--|----------------|
| 1       | All functional defects | 1) No display<br>2) Display abnormal<br>3) Missing vertical or horizontal segment<br>4) Short circuit<br>5) Backlight not working, flickering and abnormal light | Major          |
| 2       | Missing                | Missing component  |                |
| 3       | Outline dimension      | Overall outline dimension beyond the drawing dimension is not allowed  |                |

○ **COSMETIC CRITERIA**

| No. | Item                                 | Judgment Criteria   | Partition                                |
|-----|--------------------------------------|---|--|
| 1   | Difference in Spec.                  | None allowed  | Major                                    |
| 2   | Pattern peeling                      | No substrate pattern peeling and floating   | Major                                    |
| 3   | Soldering defects                    | No soldering missing<br>No soldering bridge<br>No cold soldering  | Major<br>Major<br>Minor                  |
| 4   | Resist flaw on substrate             | Invisible copper foil ( $\varnothing 0.5\text{mm}$ or more) on substrate pattern  | Minor                                    |
| 5   | Accretion of metallic Foreign matter | No soldering dust<br>No accretion of metallic foreign matters (Not exceed $\varnothing 0.2\text{mm}$ )  | Minor<br>Minor                           |
| 6   | Stain                                | No stain to spoil cosmetic badly  | Minor                                    |
| 7   | Plate discoloring                    | No plate fading, rusting and discoloring  | Minor                                    |
| 8   | Solder amount<br><br>1. Lead parts   | a. Soldering side of PCB<br>Solder to form a 'Filet' all around the lead.<br>Solder should not hide the lead form perfectly. (too much)<br>b. Components side<br>( In case of 'Through Hole PCB' )<br><br>Solder to reach the Components side of PCB.   | Minor                                    |
|     | 2. Flat packages                     | Either 'toe' (A) or 'heel' (B) of the lead to be covered by 'Filet'.<br>Lead form to be assume over solder.   |  |
|     | 3. Chips                             | $(3/2) H \geq h \geq (1/2) H$   | Minor                                    |
| 9   | Solder ball/solder splash            | a) The spacing between solder ball and the conductor or solder pad $h \geq 0.13\text{mm}$ .<br>The diameter of the solder ball $d \leq 0.15\text{mm}$ .<br>b) The quantity of solder balls or solder splashes isn't more than 5 in $600\text{mm}^2$ .<br>c) Solder balls / splashes do not violate minimum electrical clearance<br>d) Solder balls/splashes must be not be able to be dislodged with normal product usage | Minor<br><br>Minor<br><br>Major<br>Minor |

○ COSMETIC CRITERIA (non-operating)

| No.                | Defect                        | Judgment Criteria  | Classification |                               |              |           |                    |   |                    |   |           |   |       |
|--------------------|-------------------------------|--|----------------|-------------------------------|--------------|-----------|--------------------|---|--------------------|---|-----------|---|-------|
| 1                  | Spots                         | In accordance with Screen Cosmetic Criteria (Operating) No.1.  | Minor          |                               |              |           |                    |   |                    |   |           |   |       |
| 2                  | Lines                         | In accordance with Screen Cosmetic Criteria (Operating) No.2.  | Minor          |                               |              |           |                    |   |                    |   |           |   |       |
| 3                  | Bubbles in polarizer          | <table border="1"> <thead> <tr> <th>Size : d mm</th> <th>Acceptable Qty in active area</th> </tr> </thead> <tbody> <tr> <td><math>d \leq 0.3</math></td> <td>Disregard</td> </tr> <tr> <td><math>0.3 &lt; d \leq 1.0</math></td> <td>3</td> </tr> <tr> <td><math>1.0 &lt; d \leq 1.5</math></td> <td>1</td> </tr> <tr> <td><math>1.5 &lt; d</math></td> <td>0</td> </tr> </tbody> </table> | Size : d mm    | Acceptable Qty in active area | $d \leq 0.3$ | Disregard | $0.3 < d \leq 1.0$ | 3 | $1.0 < d \leq 1.5$ | 1 | $1.5 < d$ | 0 | Minor |
| Size : d mm        | Acceptable Qty in active area |  |                |                               |              |           |                    |   |                    |   |           |   |       |
| $d \leq 0.3$       | Disregard                     |  |                |                               |              |           |                    |   |                    |   |           |   |       |
| $0.3 < d \leq 1.0$ | 3                             |  |                |                               |              |           |                    |   |                    |   |           |   |       |
| $1.0 < d \leq 1.5$ | 1                             |  |                |                               |              |           |                    |   |                    |   |           |   |       |
| $1.5 < d$          | 0                             |  |                |                               |              |           |                    |   |                    |   |           |   |       |
| 4                  | Scratch                       | In accordance with spots and lines operating cosmetic criteria. When the light reflects on the panel surface, the scratches are not to be remarkable.  | Minor          |                               |              |           |                    |   |                    |   |           |   |       |
| 5                  | Allowable density             | Above defects should be separated more than 30mm each other.   | Minor          |                               |              |           |                    |   |                    |   |           |   |       |
| 6                  | Coloration                    | Not to be noticeable coloration in the viewing area of the LCD panels.<br>Back-lit type should be judged with back-lit on state only.  | Minor          |                               |              |           |                    |   |                    |   |           |   |       |
| 7                  | Contamination                 | Not to be noticeable.  | Minor          |                               |              |           |                    |   |                    |   |           |   |       |

○ COSMETIC CRITERIA (operating)

| No.                | Defect                        | Judgment Criteria   | Classification |                               |              |           |                    |   |                    |   |           |   |             |                               |              |           |                    |   |                    |   |           |   |       |
|--------------------|-------------------------------|---|----------------|-------------------------------|--------------|-----------|--------------------|---|--------------------|---|-----------|---|-------------|-------------------------------|--------------|-----------|--------------------|---|--------------------|---|-----------|---|-------|
| 1                  | Spots                         | <p>A) Clear</p> <table border="1"> <thead> <tr> <th>Size : d mm</th> <th>Acceptable Qty in active area</th> </tr> </thead> <tbody> <tr> <td><math>d \leq 0.1</math></td> <td>Disregard</td> </tr> <tr> <td><math>0.1 &lt; d \leq 0.2</math></td> <td>6</td> </tr> <tr> <td><math>0.2 &lt; d \leq 0.3</math></td> <td>2</td> </tr> <tr> <td><math>0.3 &lt; d</math></td> <td>0</td> </tr> </tbody> </table> <p>Note : Including pin holes and defective dots which must be within one pixel size.</p> <p>B) Unclear</p> <table border="1"> <thead> <tr> <th>Size : d mm</th> <th>Acceptable Qty in active area</th> </tr> </thead> <tbody> <tr> <td><math>d \leq 0.2</math></td> <td>Disregard</td> </tr> <tr> <td><math>0.2 &lt; d \leq 0.5</math></td> <td>6</td> </tr> <tr> <td><math>0.5 &lt; d \leq 0.7</math></td> <td>2</td> </tr> <tr> <td><math>0.7 &lt; d</math></td> <td>0</td> </tr> </tbody> </table> | Size : d mm    | Acceptable Qty in active area | $d \leq 0.1$ | Disregard | $0.1 < d \leq 0.2$ | 6 | $0.2 < d \leq 0.3$ | 2 | $0.3 < d$ | 0 | Size : d mm | Acceptable Qty in active area | $d \leq 0.2$ | Disregard | $0.2 < d \leq 0.5$ | 6 | $0.5 < d \leq 0.7$ | 2 | $0.7 < d$ | 0 | Minor |
| Size : d mm        | Acceptable Qty in active area |   |                |                               |              |           |                    |   |                    |   |           |   |             |                               |              |           |                    |   |                    |   |           |   |       |
| $d \leq 0.1$       | Disregard                     |   |                |                               |              |           |                    |   |                    |   |           |   |             |                               |              |           |                    |   |                    |   |           |   |       |
| $0.1 < d \leq 0.2$ | 6                             |   |                |                               |              |           |                    |   |                    |   |           |   |             |                               |              |           |                    |   |                    |   |           |   |       |
| $0.2 < d \leq 0.3$ | 2                             |   |                |                               |              |           |                    |   |                    |   |           |   |             |                               |              |           |                    |   |                    |   |           |   |       |
| $0.3 < d$          | 0                             |   |                |                               |              |           |                    |   |                    |   |           |   |             |                               |              |           |                    |   |                    |   |           |   |       |
| Size : d mm        | Acceptable Qty in active area |   |                |                               |              |           |                    |   |                    |   |           |   |             |                               |              |           |                    |   |                    |   |           |   |       |
| $d \leq 0.2$       | Disregard                     |   |                |                               |              |           |                    |   |                    |   |           |   |             |                               |              |           |                    |   |                    |   |           |   |       |
| $0.2 < d \leq 0.5$ | 6                             |   |                |                               |              |           |                    |   |                    |   |           |   |             |                               |              |           |                    |   |                    |   |           |   |       |
| $0.5 < d \leq 0.7$ | 2                             |   |                |                               |              |           |                    |   |                    |   |           |   |             |                               |              |           |                    |   |                    |   |           |   |       |
| $0.7 < d$          | 0                             |   |                |                               |              |           |                    |   |                    |   |           |   |             |                               |              |           |                    |   |                    |   |           |   |       |

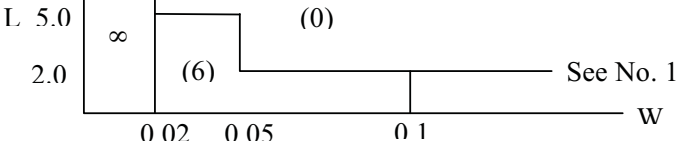
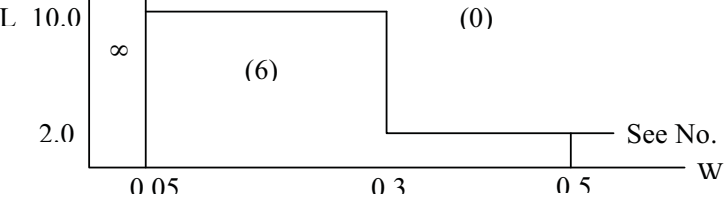
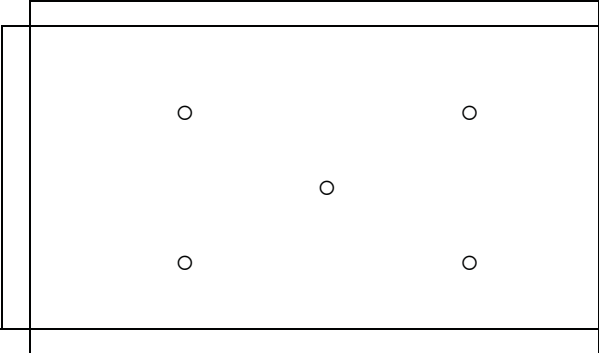
|   |  |   |       |
|---|--|---|-------|
| 2 | Lines  | <p>A) Clear</p>  <p>Note : ( ) - Acceptable Qty in active area<br/> L - Length (mm)<br/> W - Width (mm)<br/> ∞ - Disregard</p> <p>B) Unclear</p>    | Minor |
| 3 | Rubbing line                                     | Not to be noticeable.   |       |
| 4 | Allowable density                                | Above defects should be separated more than 10mm each other.  | Minor |
| 5 | Rainbow  | Not to be noticeable.   | Minor |
| 6 | Dot size   | To be 95% ~ 105% of the dot size (Typ.) in drawing.<br>Partial defects of each dot (ex. pin-hole) should be treated as 'spot'.<br>(see Screen Cosmetic Criteria (Operating) No.1)   | Minor |
| 7 | Uneven brightness<br>(only back-lit type module) | <p>Uneven brightness must be <math>B_{MAX} / B_{MIN} \leq 2</math></p> <ul style="list-style-type: none"> <li>- BMAX : Max. value by measure in 5 points</li> <li>- BMIN : Min. value by measure in 5 points</li> </ul> <p>Divide active area into 4 vertically and horizontally.<br/> Measure 5 points shown in the following figure.</p>  <p>○ : Measuring points</p> | Minor |

Note :

- (1) Size :  $d = (\text{long length} + \text{short length}) / 2$
- (2) The limit samples for each item have priority.
- (3) Complex defects are defined item by item, but if the number of defects are defined in above table, the total number should not exceed 10.
- (4) In case of 'concentration', even the spots or the lines of 'disregarded' size should not allowed.

Following three situations should be treated as 'concentration'.

- 7 or over defects in circle of  $\varnothing 5\text{mm}$ .
- 10 or over defects in circle of  $\varnothing 10\text{mm}$ .
- 20 or over defects in circle of  $\varnothing 20\text{mm}$ .

• **PRECAUTIONS FOR USING LCD MODULES**

### ○ **Handling Precautions**

(1) The display panel is made of glass. Do not subject it to a mechanical shock by dropping it or impact.

(2) If the display panel is damaged and the liquid crystal substance leaks out, be sure not to get any in your mouth. If the substance contacts your skin or clothes, wash it off using soap and water.

(3) Do not apply excessive force to the display surface or the adjoining areas since this may cause the color tone to vary.

(4) The polarizer covering the display surface of the LCD module is soft and easily scratched. Handle this polarizer carefully.

(5) If the display surface becomes contaminated, breathe on the surface and gently wipe it with a soft dry cloth. If it is heavily contaminated, moisten cloth with one of the following solvents :

- Isopropyl alcohol
- Ethyl alcohol

(6) Solvents other than those above-mentioned may damage the polarizer. Especially, do not use the following.

- Water
- Ketone
- Aromatic solvents

(7) Exercise care to minimize corrosion of the electrode. Water droplets, moisture condensation or a current flow in a high-humidity environment, accelerate corrosion of the electrodes.

(8) Install the LCD Module by using the mounting holes. When mounting the LCD module make sure it is free of twisting, warping and distortion. In particular, do not forcibly pull or bend the I/O cable or the backlight cable.

(9) Do not attempt to disassemble or process the LCD module.

(10) NC terminal should be open. Do not connect anything.

(11) If the logic circuit power is off, do not apply the input signals.

(12) To prevent destruction of the elements by static electricity, be careful to maintain an optimum work environment.

- Be sure to ground the body when handling the LCD modules.
- Tools required for assembling, such as soldering irons, must be properly grounded.
- To reduce the amount of static electricity generated, do not conduct assembling and other work under dry conditions.

- The LCD module is coated with a film to protect the display surface. Exercise care when peeling off this protective film since static electricity may be generated.

### ○ **Storage Precautions**

When storing the LCD modules, avoid exposure to direct sunlight or to the light of fluorescent lamps. Keep the modules in bags (avoid high temperature / high humidity and low temperatures below the stated storage temperature of the LCM specification).

### ○ **Others**

Liquid crystals solidify under low temperature (below the storage temperature range) leading to defective orientation or the generation of air bubbles (black or white). Air bubbles may also be generated if the module is subject to a low temperature.

If the LCD modules have been operating for a long time showing the same display patterns, the display patterns may remain on the screen as ghost images and a slight contrast irregularity may also appear. A normal operating status can be regained by suspending use for some time. It should be noted that this phenomenon does not adversely affect performance reliability.

To minimize the performance degradation of the LCD modules resulting from destruction caused by static electricity etc., exercise care to avoid holding the following sections when handling the modules.

- Exposed area of the printed circuit board.
- Terminal electrode sections.

• **USING LCD MODULES**

○ **Liquid Crystal Display Modules**

LCD is composed of glass and polarizer. Pay attention to the following items when handling.

- (1) Please keep the temperature within specified range for use and storage. Polariser degradation, bubble generation or polariser peel-off may occur if exposed to high temperature and high humidity.
- (2) Do not touch, push or rub the exposed polarisers with anything harder than an HB pencil lead (no glass object, or metal objects such as pins, tweezers, etc.)
- (3) N-hexane is recommended for cleaning the adhesives used to attach front/rear polarisers and reflectors made of organic substances that may be damaged by chemicals such as acetone, toluene, ethanol and isopropyl alcohol.
- (4) When the display surface becomes dusty, wipe gently with absorbent cotton or other soft material like chamois soaked in petroleum benzene. Do not scrub hard to avoid damaging the display surface.
- (5) Wipe off saliva or water drops immediately, contact with water over a long period of time may cause deformation or color fading.
- (6) Avoid contacting oil and fats.
- (7) Condensation on the surface and contact with terminals due to cold will damage, stain or dirty the polarisers. After products are tested at low temperature they must be warmed up in a container before coming in contact with room temperature air.
- (8) Do not put or attach anything on the display area to avoid leaving marks on.
- (9) Do not touch the display with bare hands. This will stain the display area and degrade the insulation between the terminals.
- (10) As the LCD glass is fragile, take care when handling especially on the edges.
- (11) Mounting Method – take care when handling in areas such as any PCB mounting holes, polarisers and any area on the perimeter of the LCM that can be easily damaged.
- (12) Caution against static charge - the LCD Module uses C-MOS LSI drivers, so we strongly recommend that you connect any unused input terminal to VDD or VSS, and DO NOT input any signal before power is turned on. Ensure to ground your body, any work/assembly table/area, and assembly equipment to protect against static electricity.

• **PRECAUTIONS FOR SOLDERING LCD MODULES**

|                  | Manual Soldering                    | Machine Drag Soldering              | Machine Pre-soldering                                       |
|------------------|-------------------------------------|-------------------------------------|---|
| Non ROHS Product | 290°C ~ 350°C<br>Speed : 3 ~ 5 mm/s | 330°C ~ 350°C<br>Speed : 4 ~ 8mm/s  | 300°C ~ 330°C<br>Time : 3 ~ 6S<br>Pressure : 0.8 to 1.2Mpa  |
| RoHS Product     | 340°C ~ 370°C<br>Time : 3 ~ 5S.     | 350°C ~ 370°C<br>Time : 4 ~ 8 mm/S. | 330°C ~ 360°C<br>Time : 3 ~ 6S.<br>Pressure : 0.8 ~ 1.2Mpa. |

- (1) If solder flux is used, be sure to remove any remaining flux after finishing the soldering process. (This does not apply in the case of a non-halogen type of flux.) It is recommended that you protect the LCD surface with a cover during the soldering process to prevent any damage due to the flux sparks.
- (2) When soldering a backlight panel and PCB, the panel and PCB should not be detached more than 3 times. The temperature determines this number and time conditions as mentioned in the above table, although there may be some variance depending on the actual temperature of the soldering iron.



- (3) When removing a backlight panel from the PCB, ensure the solder has completely melted, otherwise the solder pads on the backlight panel and/or PCB may be damaged.

- **Caution for operation**

- (1) It is recommended to drive LCDs within their specified voltage limit since the higher voltage than the upper limit shortens the LCD life. An electrochemical reaction due to direct current causes the LCD to deteriorate. Therefore, avoid the use of direct current drive.
- (2) Response time will be extremely delayed at lower temperatures than the operating temperature range. At higher temperatures LCD's will experience a dark color. However those phenomena do not mean a malfunction of the LCD's. Once the LCDs are returned to the specified operating temperature range, the response time and colouration should return to the normal state.
- (3) If the display area is physically pressed hard during its operation, some pixels may be abnormally displayed, but should return to their normal condition after resetting the LCM.
- (4) Moisture sitting on the LCM terminals is a cause for an electro-chemical reaction resulting in a terminal open circuit. Usage under the relative condition of 40°C, 50%RH or less is therefore required.

- **Safety**

- (1) It is recommended to crush any damaged or unnecessary LCDs into pieces and wash off the liquid crystal by using solvents such as acetone and ethanol, which should then be burned up later.
- (2) When any liquid crystal has leaked out of a damaged glass cell and comes in contact with skin, please wash it off well with soap and water.

- **Warranty**

PDI will replace or repair any of its products that are found to be functionally defective when inspected in accordance with PDI' acceptance criteria (copies available upon request) for a period of one year from date of shipment. Cosmetic/visual defects must be returned to PDI within 90 days of shipment. Confirmation of such date shall be based on freight documents. The warranty liability of PDI is limited to the repair and/or replacement on the terms set forth above. PDI will not be responsible for any subsequent or consequential losses and/or events.

#### Returning products under warranty

No warranty can be granted if the precautions stated above have been disregarded. The typical examples of violations are:

- Broken LCD glass.
- PCB eyelet's damaged or modified.
- PCB conductors damaged.
- Circuit modified in any way, including addition of components.
- PCB tampered with by grinding, engraving or painting varnish.
- Soldering to or modifying the bezel in any manner.

Product repairs will be invoiced to the customer upon mutual agreement. Products must be returned with sufficient description of the failures and/or defects. Any connectors or cable installed by the customer must be removed completely without damaging the PCB eyelet's, conductors and terminals.