



# PHOENIX DISPLAY INTERNATIONAL, INC.

---

## PHOENIX DISPLAY INTERNATIONAL, INC

### SPECIFICATION FOR LCD MODULE

<b>CUSTOMER</b>	
<b>PART NUMBER</b>	PDI020CY-T01
<b>DESCRIPTION</b>	2.0" 176 (RGB) x 220
<b>VERSION</b>	V1.0
<b>ISSUE DATE</b>	19-Apr-12

**COMPANY ADDRESS:**

Phoenix Display International, Inc.  
6150 W. Gila Springs Place Unit 2  
Chandler, AZ 85226  
USA

[www.phoenixdisplay.com](http://www.phoenixdisplay.com)

(630) 359-5700 office

(630) 359-5701 fax

## 2. General Information

ITEM	STANDARD VALUES	UNITS
LCD type	2.0" TFT	--
Dot arrangement	176 (RGB) × 220	dots
Driver IC	ILI9225	--
Module size	51.3(L) × 35.1(W) × 2.5(T)	mm
Active area	39.6 (L) × 31.68(W)	mm
Dot pitch	0.18 (L) × 0.18 (W)	mm
Back Light	3 White LED	--
Weight	TBD	G

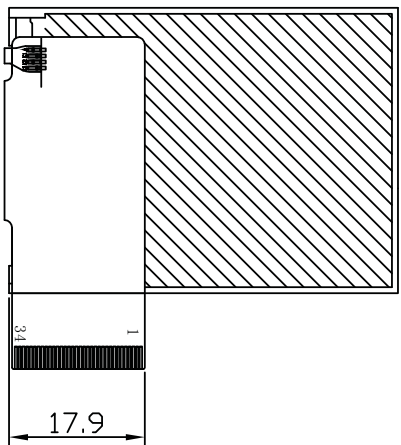
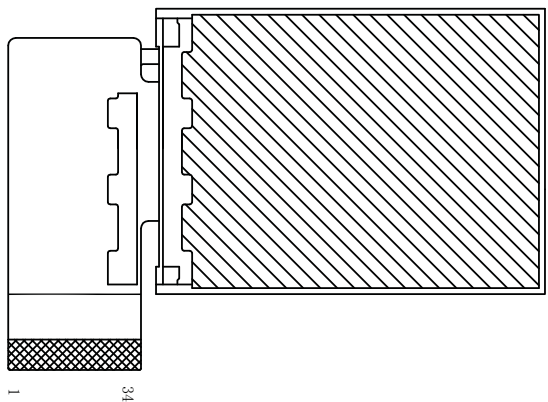
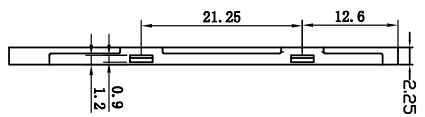
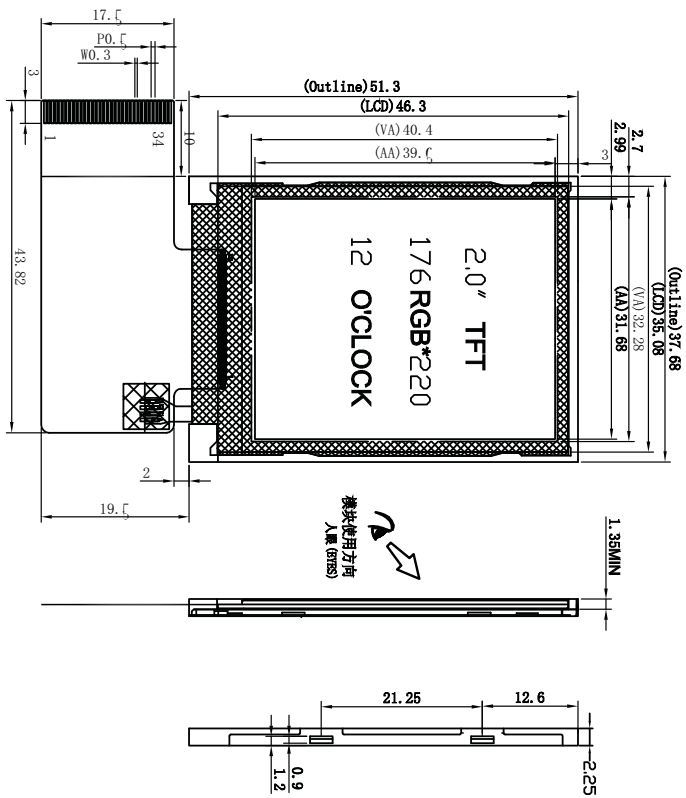

- 一. 产品特点 (Features):**
1. LCD类型: 2.0" TFT.
  2. 分辨率 (Resolution): 176\*220
  3. 显示色彩 (Color): 65K
  4. 驱动IC (Driver IC): IL1922CG
  5. 人眼观察视角 (Viewing Angle): 6° O'CLOCK
  6. 接口类型 (Interface Types): M08/9 /16/18-bit 可选.
  7. 背光类型 (Backlight Types): 3颗LED灯并联.
  8. 操作温度 (Operating Temperature): -20°C ~ 70°C .
  9. 储存温度 (Storage Temperature): -30°C ~ 80°C .
  10. 储存湿度 (Storage Humidity): 10RH ~ 40RH .
  11. 产品所有物料符合ROHS标准 (All materials comply with ROHS standard).
  12. 建议手机磁片的双面胶不要粘到触摸屏银浆以内, 以免影响TP性能及使用寿命.
  13. Vands-模块可视区域, 建议外壳可视区域比Vands单边小0.3mm以上
  14. 未注尺寸公差: ±0.2mm

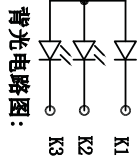

IM3/IM0=00	!80-system 16-bit interface DBI17:10J, DBI8:1J
IM3/IM0=01	!80-system 8-bit interface DBI17:10J
IM3/IM0=10	!80-system 18-bit interface DBI17:0J
IM3/IM0=11	!80-system 9-bit interface DBI17:9J

PIN DISCRPTION	
1	BL-K1
2	BL-K2
3	BL-K3
4	BL-A
5	GND
6	VDD
7	CS
8	RS
9	WR
10	RD
11	IM0
12	DB0
13	DB1
14	DB2
15	DB3
16	DB4
17	DB5
18	DB6
19	DB7
20	DB8
21	IM3
22	DB9
23	DB10
24	DB11
25	DB12
26	DB13
27	DB14
28	DB15
29	DB16
30	DB17
31	RESET
32	VCI
33	VDD
34	GND

注: 标注 请重点确认 尺寸中带有“\*”为重点管控尺寸

- 二. 防静电 PCB 设计建议及要求 (The antistatic PCB A design suggestions and requests):**
1. 在PCB信号网上接TVS管, 连接TVS管GND要接完整
  2. 信号走线, 加0V, IR, CS, PAVE, RS接在一起, 同时所接GND线
  3. 注意整个PCB接地的完整性 (Note the integrity of the entire PCB grounded).

版本 (Version)	变更历史 (Change History)	日期 (Date)	视角 (View):	比例 (Proportion):	设计 (DESIGN)	审核 (AUDITING)	批准 (APPROVED)
V1			单 位 (Unit):	页 面 (Page):	2015.6.11		
V2			M M	1 / 1			
V3			产 品 型 号 (Product Type):	V0	2015.6.11	2015.6.11	2015.6.11
			版 本 (Version):				

## 4. Interface Description

NO	SYMBOL	FUNCTION
1	BL_K1	BACK LIGHT K
2	BL_K2	BACK LIGHT K
3	BL_K3	BACK LIGHT K
4	BL_A	BACK LIGHT A,3.2V(TYP)
5	GND	GROUND
6	VDD	A supply voltage to the digital circuit. Connect to an external power supply of 1.65 ~ 3.6V
7	/CS	A chip select signal. Low: the chip is selected and accessible
8	/RS	Display data / Command selection pin. RS='1': Display data. RS='0': Command data.
9	WR	Write enable in parallel interface.
10	RD	Read enable.
11	IM0	NOTE 1*
12	DB0	DATA BUS
13	DB1	DATA BUS
14	DB2	DATA BUS
15	DB3	DATA BUS
16	DB4	DATA BUS
17	DB5	DATA BUS
18	DB6	DATA BUS
19	DB7	DATA BUS
20	DB8	DATA BUS
21	IM3	NOTE 1*
22	DB9	DATA BUS
23	DB10	DATA BUS
24	DB11	DATA BUS
25	DB12	DATA BUS
26	DB13	DATA BUS
27	DB14	DATA BUS
28	DB15	DATA BUS
29	DB16	DATA BUS
30	DB17	DATA BUS
31	RESET	A reset pin. Initializes the ILI9225G with a low input. Be sure to execute a Power-on reset after supplying power.
32	VCI	A supply voltage to the analog circuit. Connect to an external Power supply of 2.5 ~ 3.6V. 2.8V(TYP)
33	VDD	A supply voltage to the digital circuit. Connect to an external power supply of 1.65 ~ 3.6V
34	GND	GROUND

**NOTE 1**

IM3/IM0=00	i80-system	16-bit interface	DB[17:10], DB[8:1]
IM3/IM0=01	i80-system	8-bit interface	DB[17:10]
IM3/IM0=10	i80-system	18-bit interface	DB[17:0]
IM3/IM0=11	i80-system	9-bit interface	DB[17:9]

**5. Absolute Maximum Ratings**

Item	Symbol	Condition	Min.	Max.	Unit
Power Supply Voltage	$V_{DD}$	-	-0.3	4.6	V
LCD Driver Supply Voltage	VGH-VSS	-	-0.3	18.5	V
Input voltage	VCI		-0.3	4.6	V
Operating Temperature	$T_{OP}$	-	-20	+70	°C
Storage Temperature.	$T_{ST}$	-	-30	+80	°C
Storage Humidity	$H_D$	$T_a < 40\text{ °C}$	-	90	%RH

**6. Optical /Electrical Characteristics**  $V_{DD} = 2.4\sim 3.3V$ ,  $V_{SS} = 0V$ ,  $T_a = 25\text{°C}$ **6.1 Electrical Characteristics**

Item	Symbol	Condition	Min.	Type	Max.	Unit
Logic Supply Voltage	VDD	-	1.65	<b>2.8</b>	3.3	V
Analog Circuit Voltage	VCI		2.5	<b>2.8</b>	3.3	
“H” Input Voltage	$V_{IH}$	-	$0.8 V_{DD}$	-	$V_{DD}$	V
“L” Input Voltage	$V_{IL}$	-	$V_{SS}$	-	$0.2 V_{DD}$	V
“H” Output Voltage	$V_{OH}$	-	$0.8V_{DD}$	-	$V_{DD}$	V
“L” Output Voltage	$V_{OL}$	-	$V_{SS}$	-	$0.2 V_{DD}$	V
Supply Current	$I_{DD}$	$V_{DD} = 2.8V$	-	<b>TBD</b>		mA

## 6.2 Optical Characteristics

Item	Symbol	Conditions	Min.	Typ.	Max.	Reference
Back light Supply Voltage	BL_A	IF= 45mA		3.2V	3.5V	
View Angle	$\theta_{11}, \theta_{12}$	$C \geq 10, \phi = 0^\circ$	-	45	--	Note6-1
	$\theta_{21}$		-	45	--	Note6-1
	$\theta_{22}$		-	20	--	Note6-1
Contrast Ratio	C	$\theta = 0^\circ, \phi = 0^\circ$	400	500	-	--
Response Time(rise)	tr	$\theta = 0^\circ, \phi = 0^\circ$	-	2ms		Note6-3
Response Time(fall)	tf	$\theta = 0^\circ, \phi = 0^\circ$	-	6ms		Note6-3
Luminance(with LCD)	B	$\theta = 0^\circ \quad \phi = 0^\circ$	-	TBD	-	cd/m <sup>2</sup>

Note 6-1 : The definitions of viewing angles

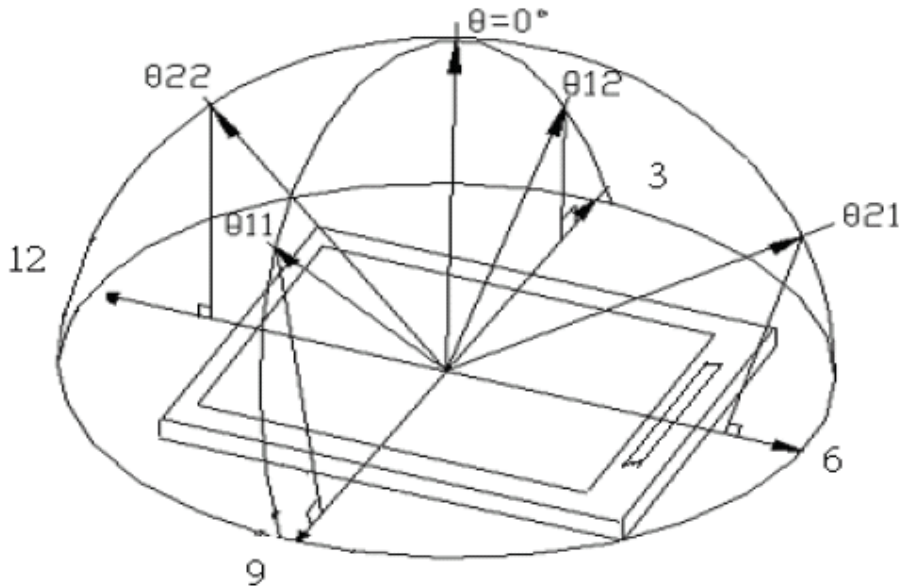

Note 6-3 : The definition of response time :

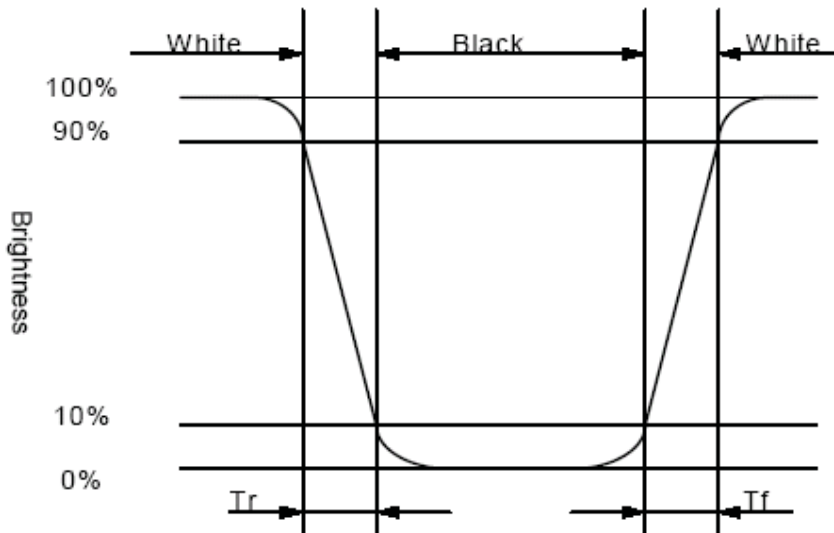

## 7. Timing Characteristics.

Please refer to ILI9225 DATASHEET.

## 8. Display Command

Please refer to ILI9225 DATASHEET.

## 10. Reliability Test Conditions And Methods

NO.	TEST ITEMS	TEST CONDITION	INSPECTION AFTER TEST
①	High Temperature Storage	$80^{\circ}\text{C} \pm 2^{\circ}\text{C} \times 200\text{Hours}$	Inspection after 2~4hours storage at room temperature, the samples should be free from defects: 1,Air bubble in the LCD. 2,Sealleak. 3,Non-display. 4,Missing segments. 5,Glass crack. 6,Current IDD is twice higher than initial value. 7, The surface shall be free from damage. 8, The electric Characteristics requirements shall be satisfied.
②	Low Temperature Storage	$- 30^{\circ}\text{C} \pm 2^{\circ}\text{C} \times 200\text{Hours}$	
③	High Temperature Operating	$70^{\circ}\text{C} \pm 2^{\circ}\text{C} \times 120\text{Hours}$	
④	Low Temperature Operating	$- 20^{\circ}\text{C} \pm 2^{\circ}\text{C} / 120\text{Hours}$	
⑤	Temperature Cycle(Storage)	$- 30^{\circ}\text{C} \pm 2^{\circ}\text{C} \longleftrightarrow 25^{\circ}\text{C}$ $80^{\circ}\text{C} \pm 2^{\circ}\text{C}$ (30min) (5min) (30min) ← 1 cycle → Total 10cycle	
⑥	Damp Proof Test	$50^{\circ}\text{C} \pm 5^{\circ}\text{C} \times 90\%RH \times 120\text{Hours}$	
⑦	Vibration Test	Frequency:10Hz~55Hz~10Hz Amplitude:1.5M X,Y,Z direction for total 3hours (Packing Condition)	

⑧	Drooping Test	Drop to the ground from 1M height one time every side of carton. (Packing Condition)	
⑨	ESD Test	Voltage: $\pm$ 8KV, R:330 $\Omega$ , C:150PF, Air Mode, 10times	

**REMARK:**

- 1, The Test samples should be applied to only one test item.
- 2, Sample side for each test item is 5~10pcs.
- 3, For Damp Proof Test, Pure water (Resistance > 10M $\Omega$ ) should be used.
- 4, In case of malfunction defect caused by ESD damage, if it would be recovered to normal state after resetting, it would be judge as a good part.
- 5, EL evaluation should be excepted from reliability test with humidity and temperature: Some defects such as black spot/blemish can happen by natural chemical reaction with humidity and Fluorescence EL has.
- 6, Failure Judgment Criterion: Basic Specification Electrical Characteristic, Mechanical Characteristic, Optical Characteristic.



# 11. Inspection Standard

This standard apply to C-STN/TFT module

## 1. Spot check plan:

According to spot check level II ,MIL-STD-105D Level II ,the rank of accept or reject is below:

3A level、 2A level : major non-conformance : AQL 0.25 minor non-conformance : AQL 0.4

A level : major non-conformance : AQL 0.65 minor non-conformance : AQL 1.

## 2. Inspection condition:

Under daylight lamp 20~40W , product distance inspector'eye 30cm,incline degree 30° 。

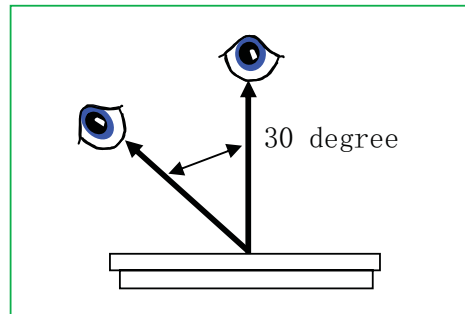

## 3. LCD area define:

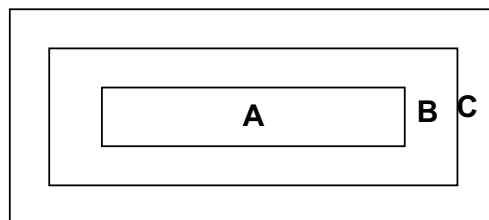

Area A: display area

Area B: VA area

Area C: out of VA area,not in sight after assembly

Remark: non-conformance at area C, but is OK that isn't influence reliability of product & assembly by customer.

#### 4. Inspection standard

##### 4.1 major non-conformance

NO.	item	Inspection standard	rate
4.1.1	Function non-conformance	1)no display,display abnormally 2)Miss line,short 3)B/L no function or function abnormally 4)TP no function	major
4.1.2	miss	No matter miss what component	
4.1.3	Out of size	Module dimension out of spec	

##### 4.2 appearance non-conformance:

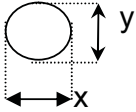
NO.	item	Inspection standard	rate																																			
4.2.1	Clearly dot	dot non-conformance define:  $\Phi = \frac{(x+y)}{2}$	minor																																			
		Most approve 3 dots,dot to dot $\geq 10\text{mm}$ <table border="1" style="margin-top: 10px;"> <thead> <tr> <th rowspan="2">area size (mm)</th> <th colspan="3">Most approve q'ty</th> </tr> <tr> <th>A</th> <th>B</th> <th>C</th> </tr> </thead> <tbody> <tr> <td><math>\Phi \leq 0.15</math></td> <td colspan="3">ignore</td> </tr> <tr> <td><math>0.15 &lt; \Phi \leq 0.20</math></td> <td colspan="3">3</td> </tr> <tr> <td><math>0.20 &lt; \Phi \leq 0.25</math></td> <td colspan="3">2</td> </tr> <tr> <td><math>0.25 &lt; \Phi \leq 0.35</math></td> <td colspan="3">1</td> </tr> <tr> <td><math>0.35 &lt; \Phi</math></td> <td colspan="3">0</td> </tr> </tbody> </table>		area size (mm)	Most approve q'ty			A	B	C	$\Phi \leq 0.15$	ignore			$0.15 < \Phi \leq 0.20$	3			$0.20 < \Phi \leq 0.25$	2			$0.25 < \Phi \leq 0.35$	1			$0.35 < \Phi$	0										
area size (mm)	Most approve q'ty																																					
	A	B	C																																			
$\Phi \leq 0.15$	ignore																																					
$0.15 < \Phi \leq 0.20$	3																																					
$0.20 < \Phi \leq 0.25$	2																																					
$0.25 < \Phi \leq 0.35$	1																																					
$0.35 < \Phi$	0																																					
	Fuzzy dot	<table border="1" style="margin-top: 10px;"> <thead> <tr> <th colspan="2">size(mm)</th> <th colspan="3">Most approve q'ty</th> </tr> <tr> <th>L (length)</th> <th>W(width)</th> <th colspan="3">area</th> </tr> <tr> <th></th> <th></th> <th>A</th> <th>B</th> <th>C</th> </tr> </thead> <tbody> <tr> <td>ignore</td> <td><math>W \leq 0.03</math></td> <td colspan="3">ignore</td> </tr> <tr> <td><math>L \leq 5.0</math></td> <td><math>0.03 &lt; W \leq 0.05</math></td> <td colspan="3">2</td> </tr> <tr> <td><math>L \leq 3.0</math></td> <td><math>0.05 &lt; W \leq 0.07</math></td> <td colspan="3">1</td> </tr> <tr> <td></td> <td><math>0.07 &lt; W</math></td> <td colspan="3">Treat with dot non-conformance</td> </tr> </tbody> </table> <p>Most approve 3 lines,line to line <math>\geq 10\text{mm}</math></p>	size(mm)		Most approve q'ty			L (length)	W(width)	area					A	B	C	ignore	$W \leq 0.03$	ignore			$L \leq 5.0$	$0.03 < W \leq 0.05$	2			$L \leq 3.0$	$0.05 < W \leq 0.07$	1				$0.07 < W$	Treat with dot non-conformance			minor
size(mm)		Most approve q'ty																																				
L (length)	W(width)	area																																				
		A	B	C																																		
ignore	$W \leq 0.03$	ignore																																				
$L \leq 5.0$	$0.03 < W \leq 0.05$	2																																				
$L \leq 3.0$	$0.05 < W \leq 0.07$	1																																				
	$0.07 < W$	Treat with dot non-conformance																																				

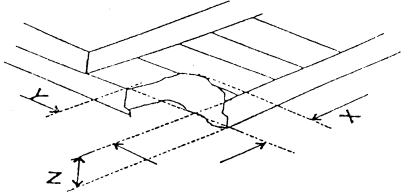
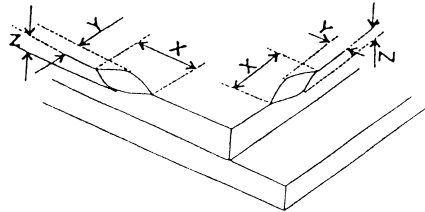
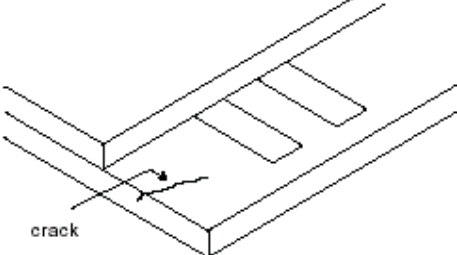
4.2.2	polarizer position	1polarizer attach meet drawing,disallow out of LCD. 2polarizer must cover display area (special require unless) .	minor						
4.2.3	LCD non-conformance	<p>(i) crash at side (remark: S=ITO length)</p>  <table border="1" data-bbox="537 535 1127 632"> <thead> <tr> <th>X</th> <th>Y</th> <th>Z</th> </tr> </thead> <tbody> <tr> <td>≤3.0</td> <td>≤S</td> <td>ignore</td> </tr> </tbody> </table> <p>Crash disallow extend to ITO or seal.</p>	X	Y	Z	≤3.0	≤S	ignore	minor
X	Y	Z							
≤3.0	≤S	ignore							
4.2.4	Contrast voltage warp	<p>(ii)commonly surface scathe</p>  <table border="1" data-bbox="516 955 1146 1052"> <thead> <tr> <th>X</th> <th>Y</th> <th>Z</th> </tr> </thead> <tbody> <tr> <td>≤2.0</td> <td>&lt;frame edge</td> <td>ignore</td> </tr> </tbody> </table> <p>(iii) crack Disallow extend crack</p>  <p>VOP/Vlcd voltage of confirmed sample ±0.15V</p>	X	Y	Z	≤2.0	<frame edge	ignore	major
X	Y	Z							
≤2.0	<frame edge	ignore							
4.2.5	color	Color & luminance of module scope reference spec	minor						
4.2.6	Cross talk	Reference confirmed limit sample	minor						

## 12. Handling Precautions

### 12.1 Mounting method

TSLCD's module consists of two thin glass plates with polarizers which easily be damaged. And since the module is so constructed as to be fixed by utilizing fitting holes in the printed circuit board.

Extreme care should be needed when handling the LCD modules.

### 12.2 Caution of LCD handling and cleaning

When cleaning the display surface, Use soft cloth with solvent [recommended below] and wipe lightly

- Isopropyl alcohol
- Ethyl alcohol

Do not wipe the display surface with dry or hard materials that will damage the polarizer surface.

Do not use the following solvent:

- Water
- Aromatics

Do not wipe ITO pad area with the dry or hard materials that will damage the ITO patterns

Do not use the following solvent on the pad or prevent it from being contaminated:

- Soldering flux
- Chlorine (Cl), Sulfur (S)

If goods were sent without being silicon coated on the pad, ITO patterns could be damaged due to the corrosion as time goes on.

If ITO corrosion happens by miss-handling or using some materials such as Chlorine (Cl), Sulfur (S) from customer, Responsibility is on customer.

### 12.3 Caution against static charge

The LCD module uses C-MOS LSI drivers, so we recommend that you:

Connect any unused input terminal to V<sub>dd</sub> or V<sub>ss</sub>, do not input any signals before power is turned on, and ground your body, work/assembly areas, assembly equipment to protect against static electricity.

### 12.4 packing

- Module employs LCD elements and must be treated as such.
- Avoid intense shock and falls from a height.
- To prevent modules from degradation, do not operate or store them exposed direct to sunshine or high temperature/humidity

### 12.5 Caution for operation

- It is an indispensable condition to drive LCD's within the specified voltage limit since the higher voltage than the limit causes the shorter LCD life.
- An electrochemical reaction due to direct current causes LCD's undesirable deterioration, so that the use of direct current drive should be avoided.
- Response time will be extremely delayed at lower temperature than the operating temperature range and on the other hand at higher temperature LCD's show dark color in them. However those phenomena do not mean malfunction or out of order with LCD's, which will come back in the specified operation temperature.
- If the display area is pushed hard during operation, some font will be abnormally displayed but it resumes normal condition after turning off once.
- A slight dew depositing on terminals is a cause for electro-chemical reaction resulting in terminal open circuit.

Usage under the maximum operating temperature, 50%Rh or less is required.

## 12.6 Storage

In the case of storing for a long period of time for instance, for years for the purpose or replacement use, the following ways are recommended.

- Storage in a polyethylene bag with the opening sealed so as not to enter fresh air outside in it . And with no desiccant.
- Placing in a dark place where neither exposure to direct sunlight nor light's keeping the storage temperature range.
- Storing with no touch on polarizer surface by the anything else.  
[It is recommended to store them as they have been contained in the inner container at the time of delivery from us

## 12.7 Safety

- It is recommendable to crash damaged or unnecessary LCD's into pieces and wash off liquid crystal by either of solvents such as acetone and ethanol, which should be burned up later.
- When any liquid leaked out of a damaged glass cell comes in contact with your hands, please wash it off well with soap and water

## 13. Precaution For Use

### 13.1

A limit sample should be provided by the both parties on an occasion when the both parties agreed its necessity. Judgment by a limit sample shall take effect after the limit sample has been established and confirmed by the both parties.

### 13.2

On the following occasions, the handing of problem should be decided through discussion and agreement between responsible of the both parties.

- When a question is arisen in this specification
- When a new problem is arisen which is not specified in this specifications
- When an inspection specifications change or operating condition change in customer is reported to NS Co.,Ltd , and some problem is arisen in this specification due to the change
- When a new problem is arisen at the customer's operating set for sample evaluation in the customer site.

## 14. Packaging Required

PARAMETER	Specification	Unit
Outside box	390(L) x 350(W) x 480(H)	mm
Inside pearl wool box	330(L)x185(W)x110(H)	mm
Product quantity of Inside box	64	pcs
Total product quantity	64*8=512	pcs
Total weight	11 ±0.5	Kg