



# PHOENIX DISPLAY INTERNATIONAL, INC.

---

## PHOENIX DISPLAY INTERNATIONAL, INC

### SPECIFICATION FOR LCD MODULE

<b>CUSTOMER</b>	
<b>PART NUMBER</b>	PDI080WVSH-03
<b>DESCRIPTION</b>	8.0" 800 x 3(RGB)x480
<b>VERSION</b>	V1.0
<b>ISSUE DATE</b>	07-Apr-18

**COMPANY ADDRESS:**

Phoenix Display International, Inc.  
6150 W. Gila Springs Place Unit 2  
Chandler, AZ 85226  
USA  
[www.phoenixdisplay.com](http://www.phoenixdisplay.com)  
(630) 359-5700 office  
(630) 359-5701 fax

---

Record of  
Revision

Version	Revise Date	Page	Content
Pre-Spec.01	2018/4/07		Initial Release

---

# Contents

1. General Specifications .....	1
2. Pin Assignment.....	2
3. Operation Specifications .....	5
3.1. Absolute Maximum Rating.....	5
3.1.1. Typical Operation Conditions.....	6
3.1.2. Current Consumption .....	7
3.1.3. Backlight Driving Conditions .....	7
3.2. Power Sequence .....	8
3.3. Timing Characteristics .....	9
3.3.1. AC Electrical Characteristics .....	9
3.3.2. Data Input Format.....	10
3.3.3. Timing.....	11
4. Optical Specifications.....	12
5. Reliability Test Items .....	16
6. General Precautions .....	17
6.1. Safety .....	17
6.2. Handling .....	17
6.3. Static Electricity .....	17
6.4. Storage .....	17
6.5. Cleaning .....	17
7. Mechanical Drawing .....	18
8. Package .....	21
8.1Packaging Material Table.....	21

---

# 1 . General Specifications

No.	Item	Specification	Remark
1	LCD size	8.0 inch(Diagonal)	
2	Driver element	a-Si TFT active matrix	
3	Resolution	800 × 3(RGB) × 480	
4	Display mode	Normally White, Transmissive	
5	Dot pitch	0.0736(W) × 0.2070(H) mm	
6	Active area	176.64(W) × 99.36(H) mm	
7	Module size	192.8(W) × 117.0(H) × 6.4(D) mm	Note 1
8	Surface treatment	Anti-Glare	
9	Color arrangement	RGB-stripe	
10	Interface	Digital	
11	Backlight power consumption	2.232W (Typ.)	
12	Panel power consumption	0.268W (Typ.)	
13	Weight	TBD.	

Note 1: Refer to Mechanical Drawing.

---

## 2. Pin Assignment

### TFT LCD Panel Driving Section

FPC Connector is used for the module electronics interface. The recommended model is FH12A-50S-0.5SH manufactured by Hirose.

Pin No.	Symbol	I/O	Function	Remark
1	V <sub>LED+</sub>	P	Power for LED backlight (Anode)	
2	V <sub>LED+</sub>	P	Power for LED backlight (Anode)	
3	V <sub>LED-</sub>	P	Power for LED backlight (Cathode)	
4	V <sub>LED-</sub>	P	Power for LED backlight (Cathode)	
5	GND	P	Power ground	
6	V <sub>COM</sub>	I	Common voltage	
7	DV <sub>DD</sub>	P	Power for Digital Circuit	
8	MODE	I	DE/SYNC mode select	Note 1
9	DE	I	Data Input Enable	
10	VS	I	Vertical Sync Input	
11	HS	I	Horizontal Sync Input	
12	B7	I	Blue data(MSB)	
13	B6	I	Blue data	
14	B5	I	Blue data	
15	B4	I	Blue data	
16	B3	I	Blue data	
17	B2	I	Blue data	
18	B1	I	Blue data	Note 2
19	B0	I	Blue data(LSB)	Note 2
20	G7	I	Green data(MSB)	
21	G6	I	Green data	
22	G5	I	Green data	
23	G4	I	Green data	
24	G3	I	Green data	
25	G2	I	Green data	

26	G1	I	Green data	Note 2
27	G0	I	Green data(LSB)	Note 2
28	R7	I	Red data(MSB)	
29	R6	I	Red data	
30	R5	I	Red data	
31	R4	I	Red data	
32	R3	I	Red data	
33	R2	I	Red data	
34	R1	I	Red data	Note 2
35	R0	I	Red data(LSB)	Note 2
36	GND	P	Power Ground	
37	DCLK	I	Sample clock	Note 3
38	GND	P	Power Ground	
39	L/R	I	Left / right selection	Note 4,5
40	U/D	I	Up/down selection	Note 4,5
41	V <sub>GH</sub>	P	Gate ON Voltage	
42	V <sub>GL</sub>	P	Gate OFF Voltage	
43	AV <sub>DD</sub>	P	Power for Analog Circuit	
44	RESET	I	Global reset pin.	Note 6
45	NC	-	No connection	
46	V <sub>COM</sub>	I	Common Voltage	
47	DITHB	I	Dithering function	Note 7
48	GND	P	Power Ground	
49	NC	-	No connection	
50	NC	-	No connection	

I: input, O: output, P: Power

Note 1: DE/SYNC mode select. Normally pull high.

When select DE mode, MODE="1", VS and HS must pull high.

When select SYNC mode, MODE="0", DE must be grounded.

Note 2: When input 18 bits RGB data, the two low bits of R,G and B data must be grounded.

Note 3: Data shall be latched at the falling edge of DCLK.

Note 4: Selection of scanning mode

Setting of scan control input		Scanning direction
U/D	L/R	
GND	DV <sub>DD</sub>	Up to down, left to right
DV <sub>DD</sub>	GND	Down to up, right to left
	GND	Up to down, right to left
DV <sub>DD</sub>	DV <sub>DD</sub>	Down to up, left to right

Note 5: Definition of scanning direction.  
Refer to the figure as below:

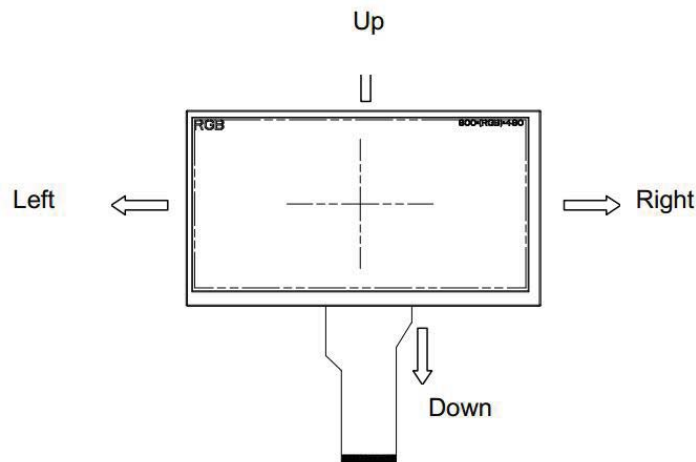

Note 6: Global reset pin. Active low to enter reset state. Suggest to connect with an RC reset circuit for stability. Normally pull high.

Note 7: Dithering function enable control, normally pull high.

When DITHB="1", Disable internal dithering function,  
When DITHB="0", Enable internal dithering function,

---

## 3. Operation Specifications

### 3.1. Absolute Maximum Ratings

(Note 1)

Item	Symbol	Values		Unit	Remark
		Min.	Max.		
Power voltage	$DV_{DD}$	-0.3	5.0	V	
	$AV_{DD}$	6.5	13.5	V	
	$V_{GH}$	-0.3	40.0	V	
	$V_{GL}$	-20.0	0.3	V	
	$V_{GH}-V_{GL}$	-	40.0	V	
Operation Temperature	$T_{OP}$	-20	70	°C	
Storage Temperature	$T_{ST}$	-30	80	°C	
LED Reverse Voltage	$V_R$	-	1.2	V	Each LED Note 2
LED Forward Current	$I_F$	-	25	mA	Each LED

Note 1: The absolute maximum rating values of this product are not allowed to be exceeded at any times. Should a module be used with any of the absolute maximum ratings exceeded, the characteristics of the module may not be recovered, or in an extreme case, the module may be permanently destroyed.

Note 2:  $V_R$  Conditions: Zener Diode 20mA



### 3.1.1. Typical Operation Conditions

( Note 1)

Item	Symbol	Values			Unit	Remark
		Min.	Typ.	Max.		
Power voltage	DV <sub>DD</sub>	3.0	3.3	3.6	V	Note 2
	AV <sub>DD</sub>	10.2	10.4	10.6	V	
	V <sub>GH</sub>	15.3	16.0	16.7	V	
	V <sub>GL</sub>	-7.7	-7.0	-6.3	V	
Input signal voltage	V <sub>COM</sub>	4.2	4.4	4.6	V	
Input logic high voltage	V <sub>IH</sub>	0.7 DV <sub>DD</sub>	-	DV <sub>DD</sub>	V	Note 3
Input logic low voltage	V <sub>IL</sub>	0	-	0.3 DV <sub>DD</sub>	V	

Note 1: Be sure to apply DV<sub>DD</sub> and V<sub>GL</sub> to the LCD first, and then apply V<sub>GH</sub>. Note

2: DV<sub>DD</sub> setting should match the signals output voltage (refer to Note 3) of customer's system board.

Note 3: DCLK,HS,VS,RESET,U/D, L/R,DE,R0~R7,G0~G7,B0~B7,MODE,DITHB.

### 3.1.2.Current Consumption

Item	Symbol	Values			Unit	Remark
		Min.	Typ.	Max.		
Current for Driver	$I_{GH}$	-	0.2	1.0	mA	$V_{GH} = 16.0V$
	$I_{GL}$	-	0.2	1.0	mA	$V_{GL} = -7.0V$
	$IDV_{DD}$	-	4.0	10	mA	$DV_{DD} = 3.3V$
	$I_{AV_{DD}}$	-	20	50	mA	$AV_{DD} = 10.4V$

### 3.1.3.Backlight Driving Conditions

Item	Symbol	Values			Unit	Remark
		Min.	Typ.	Max.		
Voltage for LED backlight	$V_L$	8.4	9.3	10.2	V	Note 1
Current for LED backlight	$I_L$	216	240	264	mA	
LED life time	-	20,000	-	-	Hr	Note 2

Note 1: The LED Supply Voltage is defined by the number of LED at  $T_a=25^{\circ}C$  and  $I_L = 260mA$ .

Note 2: The "LED life time" is defined as the module brightness decrease to 50% original brightness at  $T_a=25^{\circ}C$  and  $I_L = 240mA$ . The LED lifetime could be decreased if operating  $I_L$  is larger than 240mA.

## 3.2. Power Sequence

a. Power on:

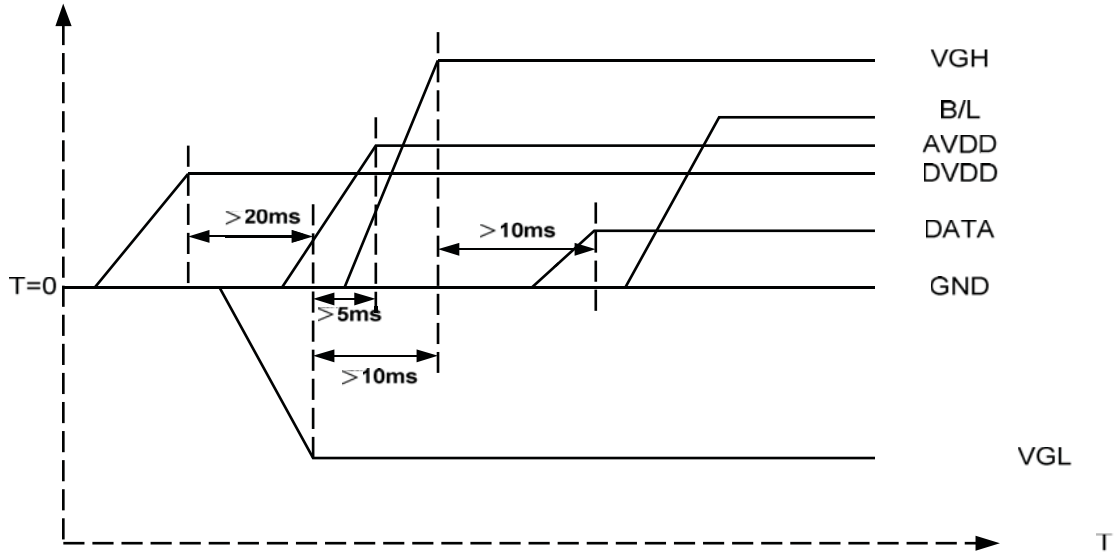

DVDD → VGL → VGH → Data → B/L

b. Power off:

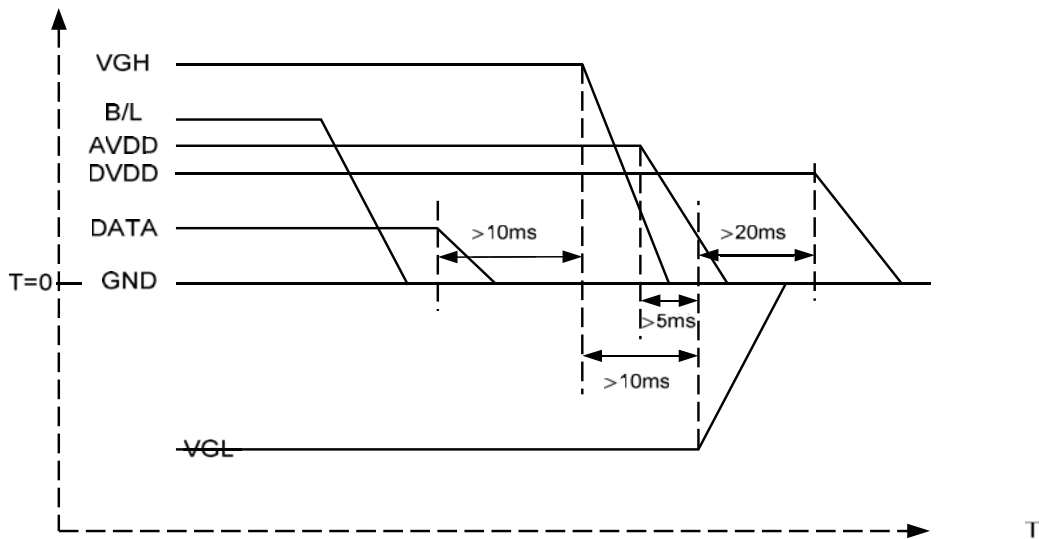

B/L → Data → VGH → VGL → DV<sub>DD</sub>

Note: Data include R0~R7, B0~B7, GO~G7, U/D, L/R, DCLK, HS, VS, DE.

### 3.3. Timing Characteristics

#### 3.3.1. AC Electrical Characteristics

Item	Symbol	Values			Unit	Remark
		Min.	Typ.	Max.		
HS setup time	$T_{hst}$	8	-	-	ns	
HS hold time	$T_{hhd}$	8	-	-	ns	
VS setup time	$T_{vst}$	8	-	-	ns	
VS hold time	$T_{vhd}$	8	-	-	ns	
Data setup time	$T_{dsu}$	8	-	-	ns	
Data hole time	$T_{dhd}$	8	-	-	ns	
DE setup time	$T_{esu}$	8	-	-	ns	
DE hole time	$T_{ehd}$	8	-	-	ns	
DV <sub>DD</sub> Power On Slew rate	$T_{POR}$	-	-	20	ms	From 0 to 90% DV <sub>DD</sub>
RESET pulse width	$T_{Rst}$	1	-	-	ms	
DCLK cycle time	$T_{coh}$	20	-	-	ns	
DCLK pulse duty	$T_{cwh}$	40	50	60	%	

### 3.3.2.Data Input Format

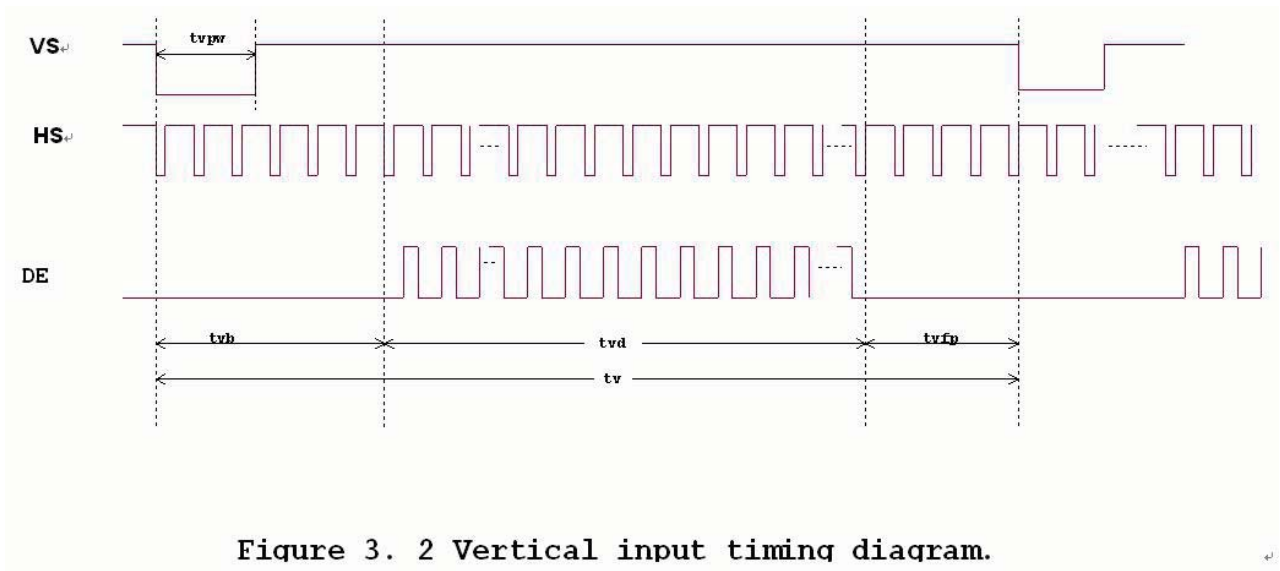
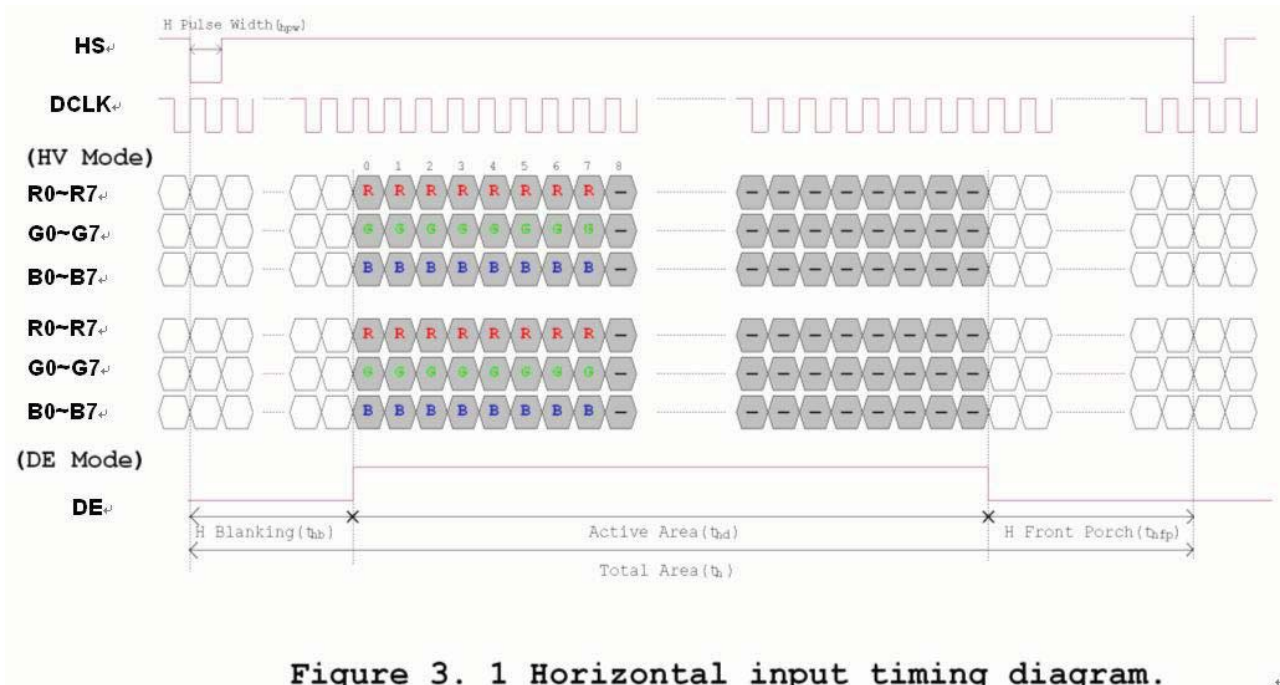

### 3.3.3. Timing

Item	Symbol	Values			Unit	Remark
		Min.	Typ.	Max.		
Horizontal Display Area	thd	-	800	-	DCLK	
DCLK Frequency	fclk	26.4	33.3	46.8	MHz	
One Horizontal Line	th	862	1056	1200	DCLK	
HS pulse width	thpw	1	-	40	DCLK	
HS Blanking	thb	46	46	46	DCLK	
HS Front Porch	thfp	16	210	354	DCLK	

Item	Symbol	Values			Unit	Remark
		Min.	Typ.	Max.		
Vertical Display Area	tvd	-	480	-	TH	
VS period time	tv	510	525	650	TH	
VS pulse width	tvpw	1	-	20	TH	
VS Blanking	tvb	23	23	23	TH	
VS Front Porch	tvfp	7	22	147	TH	

## 4. Optical Specifications

Item	Symbol	Condition	Values			Unit	Remark
			Min.	Typ.	Max.		
Viewing angle (CR≥ 10)	$\theta_L$	$\Phi=180^\circ$ (9 o'clock)	60	70	-	degree	Note 1
	$\theta_R$	$\Phi=0^\circ$ (3 o'clock)	60	70	-		
	$\theta_T$	$\Phi=90^\circ$ (12 o'clock)	40	50	-		
	$\theta_B$	$\Phi=270^\circ$ (6 o'clock)	60	70	-		
Response time	$T_{ON}$	Normal $\theta=\Phi=0^\circ$	-	10	20	msec	Note 3
	$T_{OFF}$		-	15	30	msec	Note 3
Contrast ratio	CR		400	500	-	-	Note 4
Color chromaticity	$W_X$		0.26	0.31	0.36	-	Note 2 Note 5
	$W_Y$		0.28	0.33	0.38	-	Note 6
Luminance	L		450	500	-	cd/m <sup>2</sup>	Note 6
Luminance uniformity	$Y_U$		70	75	-	%	Note 7

### Test Conditions:

1.  $DV_{DD}=3.3V$ ,  $I_L=240mA$  (Backlight current), the ambient temperature is 25°C.
2. The test systems refer to Note 2.

Note 1: Definition of viewing angle range

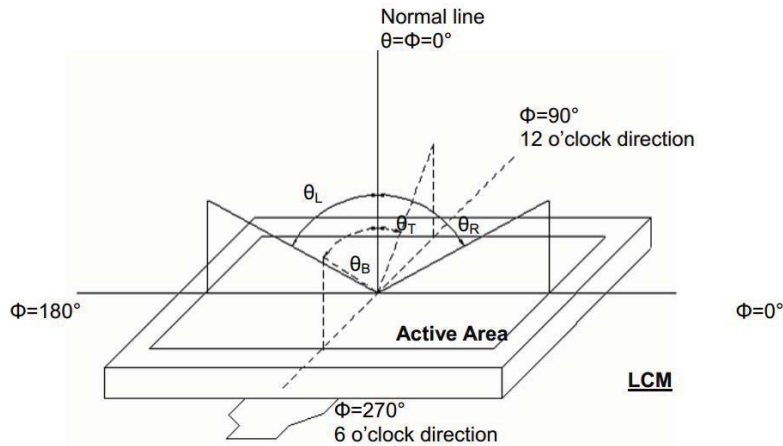

Fig. 4-1 Definition of viewing angle

Note 2: Definition of optical measurement system.

The optical characteristics should be measured in dark room. After 30 minutes operation, the optical properties are measured at the center point of the LCD screen. (Response time is measured by Photo detector TOPCON BM-7, other items are measured by BM-5A/Field of view: 1° /Height: 500mm.)

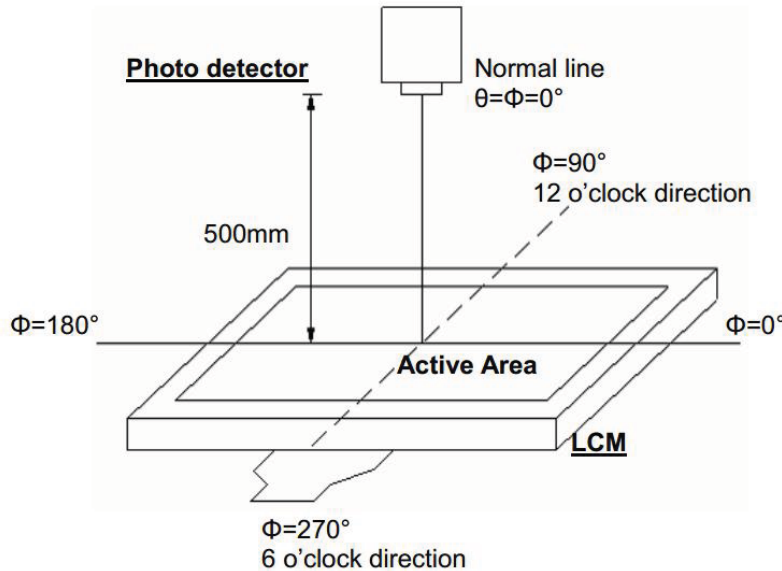

Fig. 4-2 Optical measurement system setup

Note 3: Definition of Response time

The response time is defined as the LCD optical switching time interval between "White" state and "Black" state. Rise time ( $T_{ON}$ ) is the time between photo detector output intensity changed from 90% to 10%. And fall time ( $T_{OFF}$ ) is the time between photo detector output intensity changed from 10% to 90%.

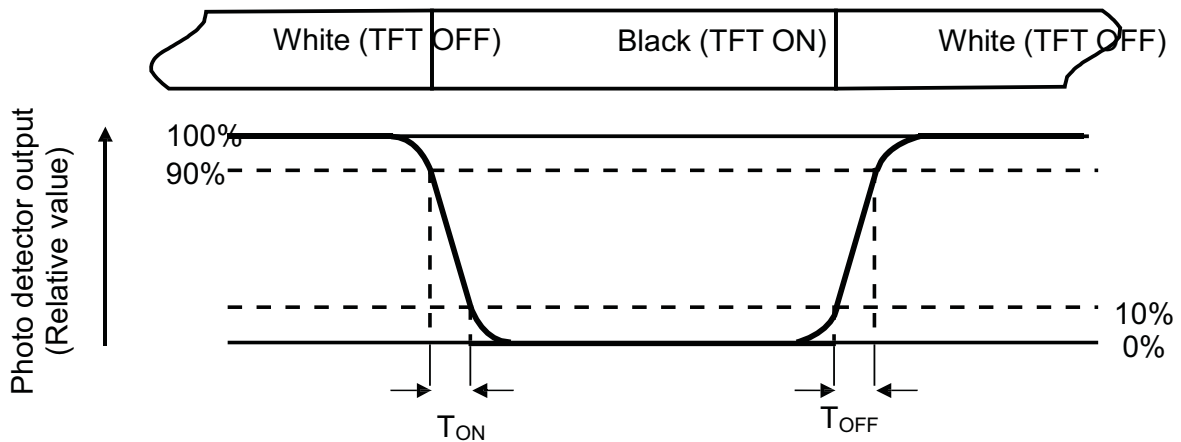

Fig. 4-3 Definition of response time



Note 4: Definition of contrast ratio

$$\text{Contrast ratio (CR)} = \frac{\text{Luminance measured when LCD on the "White" state}}{\text{Luminance measured when LCD on the "Black" state}}$$

Note 5: Definition of color chromaticity (CIE1931)  
Color coordinates measured at center point of LCD.

Note 6: All input terminals LCD panel must be ground while measuring the center area of the panel. The LED driving condition is  $I_L=260\text{mA}$ .

Note 7: Definition of Luminance Uniformity

Active area is divided into 9 measuring areas (Refer to Fig. 4-4 ).Every measuring point is placed at the center of each measuring area.

$$\text{Luminance Uniformity (Yu)} = \frac{B_{min}}{B_{max}}$$

L-----Active area length      W----- Active area width

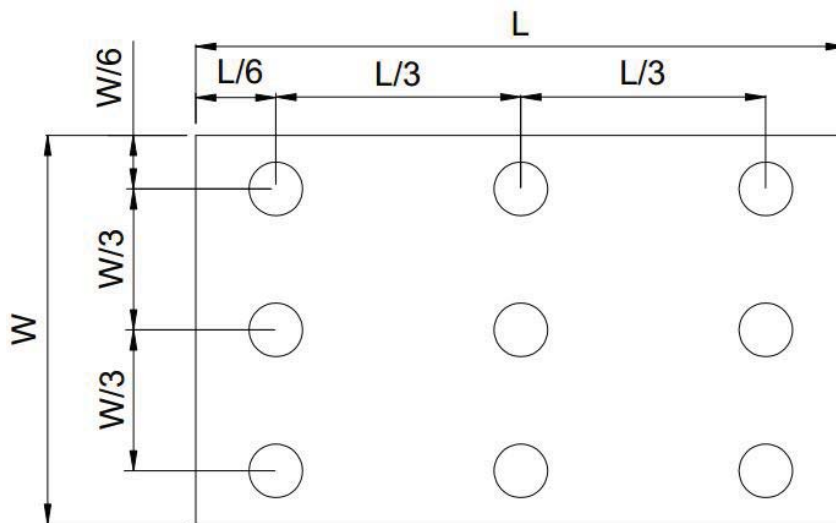

Fig. 4-4 Definition of measuring points

$B_{max}$ : The measured maximum luminance of all measurement position.

$B_{min}$ : The measured minimum luminance of all measurement position.

## 5. Reliability Test Items

(Note3)

Item	Test Conditions	Remark
High Temperature Storage	Ta = 85°C                      240hrs	Note 1 , Note 4
Low Temperature Storage	Ta = -30°C                      240hrs	Note 1 , Note 4
High Temperature Operation	Ts = 85°C                      240hrs	Note 2 , Note 4
Low Temperature Operation	Ta = -30°C                      240hrs	Note 1 , Note 4
Operate at High Temperature and Humidity	+60°C, 90%RH                      240hrs	Note 4
Thermal Shock	-30°C/30 min ~ +85°C/30 min for a total 100 cycles, Start with cold temperature and end with high temperature.	Note 4
Vibration Test	Frequency range:10~55Hz Stroke:1.5mm Sweep:10Hz~55Hz~10Hz 2 hours for each direction of X. Y. Z. (6 hours for total)	
Mechanical Shock	100G 6ms,±X, ±Y, ±Z 3 times for each direction	
Package Vibration Test	Random Vibration : 0.015G*G/Hz from 5-200HZ, -6dB/Octave from 200-500HZ 2 hours for each direction of X. Y. Z. (6 hours for total)	
Package Drop Test	Height:60 cm 1 corner, 3 edges, 6 surfaces	
Electro Static Discharge	± 2KV, Human Body Mode, 100pF/1500Ω	

Note 1: Ta is the ambient temperature of samples.

Note 2: Ts is the temperature of panel's surface.

Note 3: In the standard condition, there shall be no practical problem that may affect the display function. After the reliability test, the product only guarantees operation, but don't guarantee all of the cosmetic specification.

Note 4: Before cosmetic and function test, the product must have enough recovery time, at least 2 hours at room temperature.

---

## 6.1.Safety

Liquid crystal is poisonous. Do not put it in your mouth. If liquid crystal touches your skin or clothes, wash it off immediately by using soap and water.

## 6.2.Handling

1. The LCD panel is plate glass. Do not subject the panel to mechanical shock or to excessive force on its surface.
2. The polarizer attached to the display is easily damaged. Please handle it carefully to avoid scratch or other damages.
3. To avoid contamination on the display surface, do not touch the module surface with bare hands.
4. Keep a space so that the LCD panels do not touch other components.
5. Put cover board such as acrylic board on the surface of LCD panel to protect panel from damages.
6. Transparent electrodes may be disconnected if you use the LCD panel under environmental conditions where the condensation of dew occurs.
7. Do not leave module in direct sunlight to avoid malfunction of the ICs.

## 6.3.Static Electricity

1. Be sure to ground module before turning on power or operating module.
2. Do not apply voltage which exceeds the absolute maximum rating value.

## 6.4.Storage

1. Store the module in a dark room where must keep at  $25\pm 10^{\circ}\text{C}$  and 65%RH or less.
2. Do not store the module in surroundings containing organic solvent or corrosive gas.
3. Store the module in an anti-electrostatic container or bag.

## 6.5.Cleaning

1. Do not wipe the polarizer with dry cloth. It might cause scratch.
2. Only use a soft sloth with IPA to wipe the polarizer, other chemicals might permanent damage to the polarizer.

# 7. Mechanical Drawing

GENERAL TOLERANCE: ±0.2	
LCD Type	8.0" TFT, Transmissive, Normally white, TN
Resolution	800(RGB)*480
View Direction	12 O'CLOCK
Driver IC	TBD
Color Depth	16.7M
Interface Types	TTI(RGB24-bit)
Operating voltage	3.3V
TPLens	Without
Backlight LEDs	36 LEDs, 240mA, 9.3V
Surface luminance	500 cd/m <sup>2</sup>
Operating temperature	-20 °C~70 °C
Storage Temperature	-30 °C~80 °C
High Temperature & High Humidity	70°C, 90% max

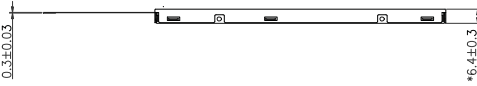
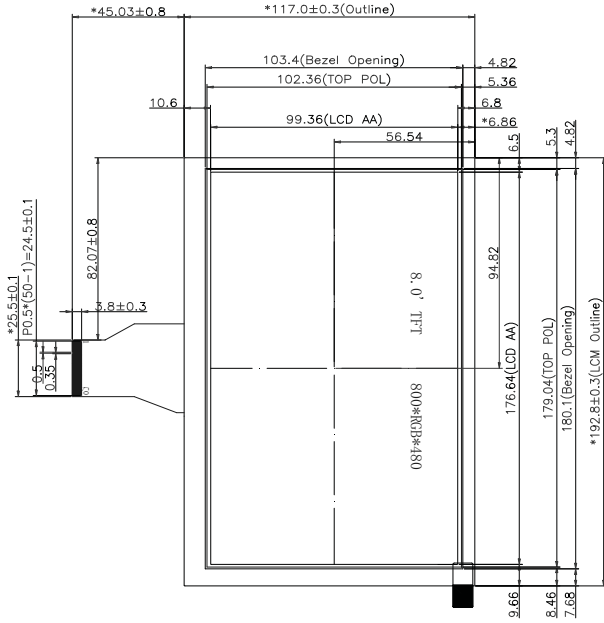

Single Layer Area

Item	Symbol	values			Unit
		MIN	TYP	MAX	
power voltage	DVDD	3.0	3.3	3.6	V
	AVDD	9.4	9.6	9.8	V
	VGL	15.3	16	16.7	V
	VQL	-7.7	-7	-6.3	V
Pant signal low voltage	VDM	4.2	4.4	4.6	V
	VH	0.7 DVDD	-	DVDD	V
Pant signal low voltage	VIL	0	-	0.3DVDD	V

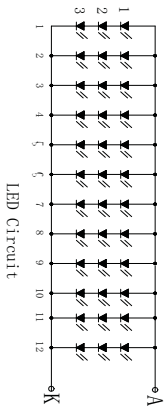

the key size with \*

版本 (Version)	变更记录 (Change History)	日期 (Date)	视角 (View):	比例 (Proportion):	设计 (DESIGN)	审核 (AUDITING)	批准 (APPROVED)
V1			单位 (Unit): M M	页 面 (Page): 1 / 1	Arcon 2017.10.25	Perix 2017.10.25	
V2			产品型号 (Product Type):				

1	VDD+	26	G1
2	VDD-	27	G0
3	VDD-	28	R7
4	VDD-	29	R6
5	GND	30	R5
6	VDD	31	R4
7	VDD	32	R3
8	VDD	33	R2
9	DE	34	R1
10	VSS	35	RO
11	VSS	36	GND
12	B7	37	DCLK
13	B6	38	GND
14	B5	39	L/R
15	B4	40	U/D
16	B3	41	VGL
17	B2	42	VGL
18	B1	43	A/D0
19	B0	44	BSET
20	G7	45	NC
21	G6	46	VDD
22	G5	47	DDIM
23	G4	48	GND
24	G3	49	NC
25	G2	50	NC

## 8. Package

### 8.1. Packaging Material Table

<b>PARAMETER</b>	<b>Specification</b>	<b>Unit</b>
Outside box	390(L) x 350(W) x 480(H)	mm
Inside box	33.5x50x15	cm
Product quantity of Inside box	24	pcs
Total weight	TBD.	KG